

DETAIL-1.0

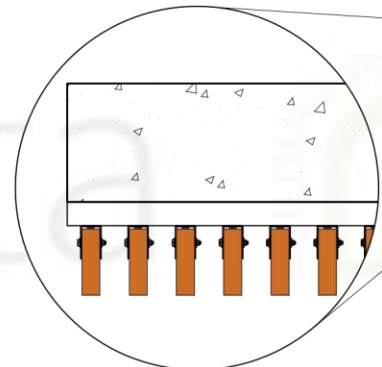

DETAIL-3.0

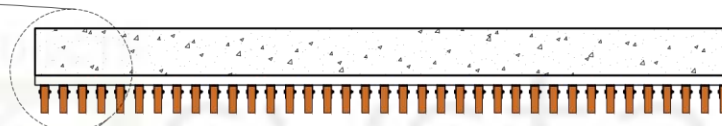

TOP VIEW

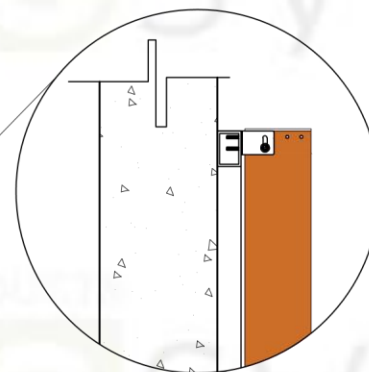

DETAIL-5.0

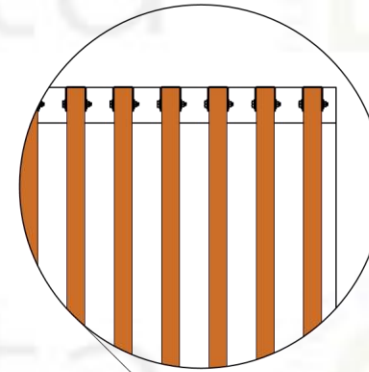

DETAIL-4.0

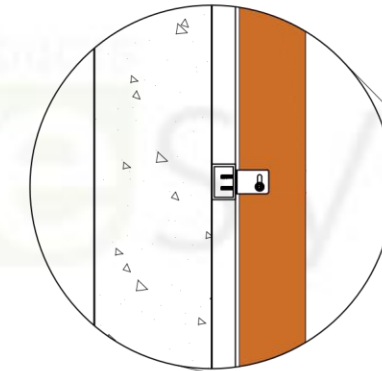

DETAIL-6.0

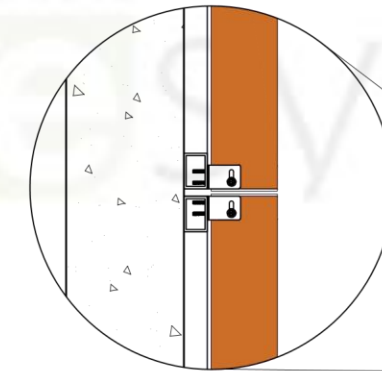

DETAIL-7.0

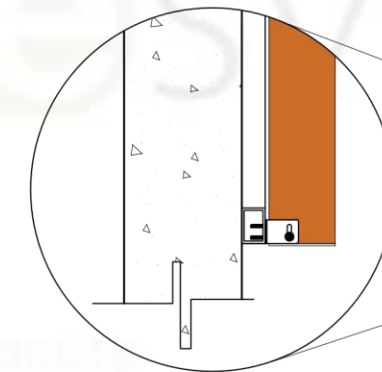

DETAIL-8.0

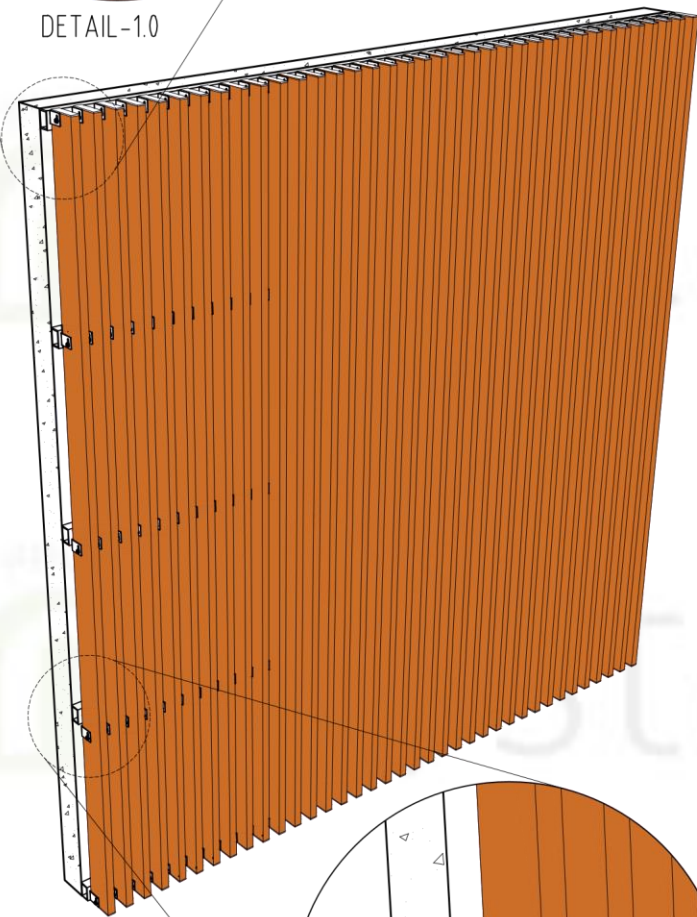

PERSPECTIVE

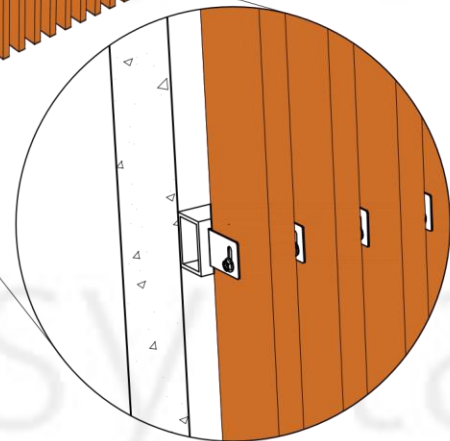

DETAIL-2.0

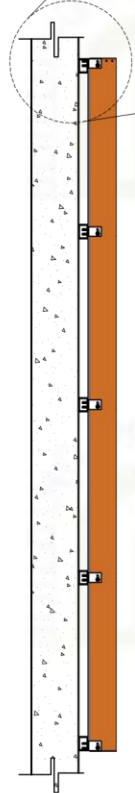

SIDE ELEVATION

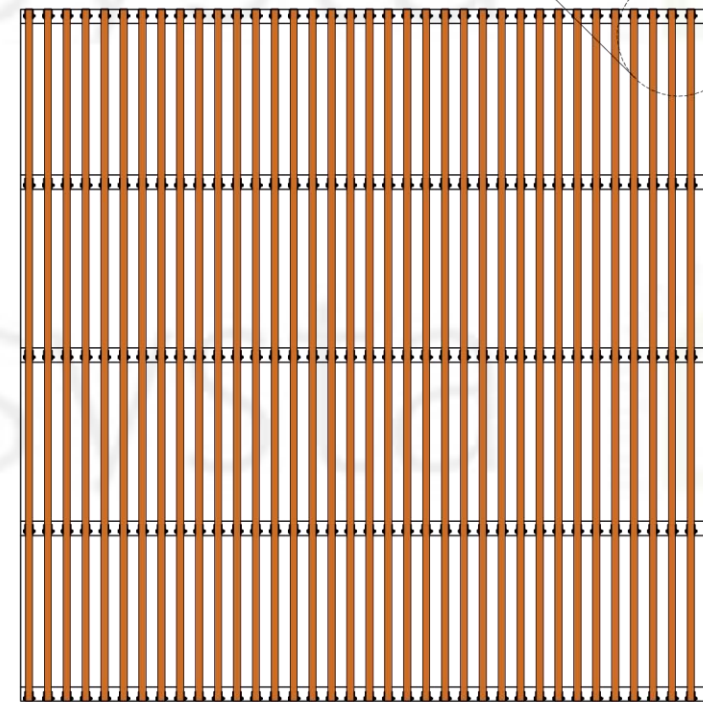

FRONT ELEVATION

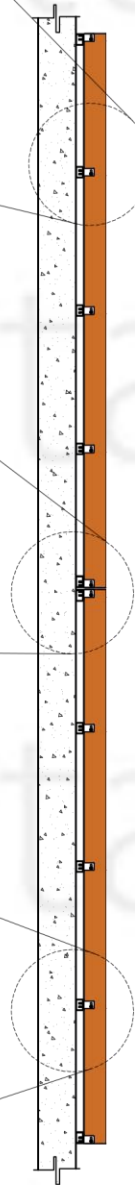

MULTI-BOARD
SIDE ELEVATION

1 **4CH VERTICAL CLADDING U-BRACKET**
4VCUB RESYSTA PROFILE WITHOUT ALUMINUM INSERT (RESGC020612)



NOTE

THIS DRAWING AS AN INSTRUMENT OF SERVICE, IS THE PROPERTY OF RESYSTA AND AS SUCH MUST NOT BE REPRODUCED OR COPIED IN PART OR IN WHOLE WITHOUT THE PERMISSION OF THE AUTHOR.

TITLE	SPECIFICATION	SHEET CONTENT	SHEET SIZE	DRAWING NO.	CONTINENT
4CH - U Bracket VERTICAL CLADDING DETAIL	TYPICAL DRAWING DETAIL	PERSPECTIVE	A3	4VCUB-11	RESYSTA USA
		TOP VIEW			
		FRONT ELEVATION	DATE	REVISION	
		SIDE ELEVATION	27.02.23	0	
		MULTI-BOARD SIDE ELEVATION			

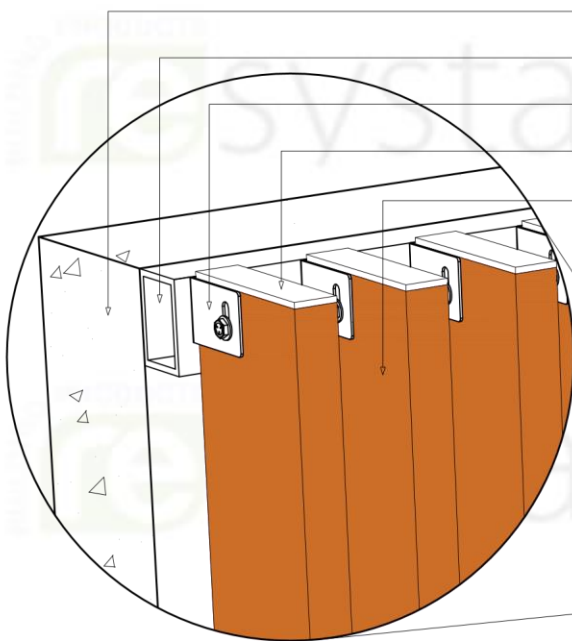

DETAIL - 1.0
END PART

- EXISTING WALL
- SUBSTRUCTURE BY OTHERS
- RESUB112234 Aluminum U-Bracket with Bolt, washer and nut
- RESCAP0206Cxx Hollow Cap
- RESGC020612 Cladding (4CH)

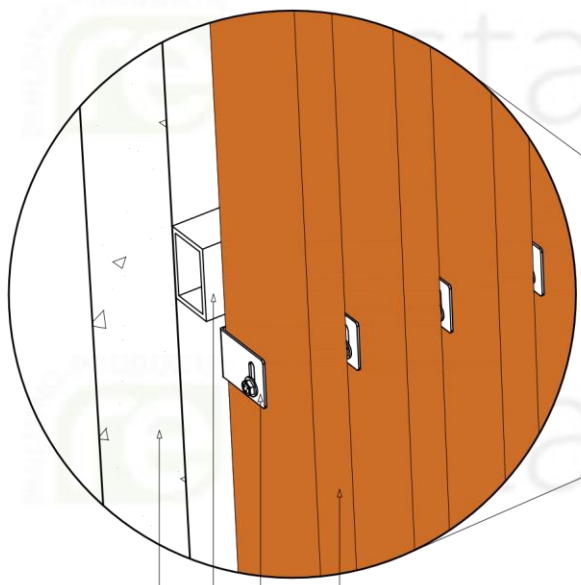

DETAIL - 12.0
MIDDLE PART

- RESGC020612 Cladding (4CH)
- RESUB112234 Aluminum U-Bracket with Bolt, washer and nut
- SUBSTRUCTURE BY OTHERS
- EXISTING WALL

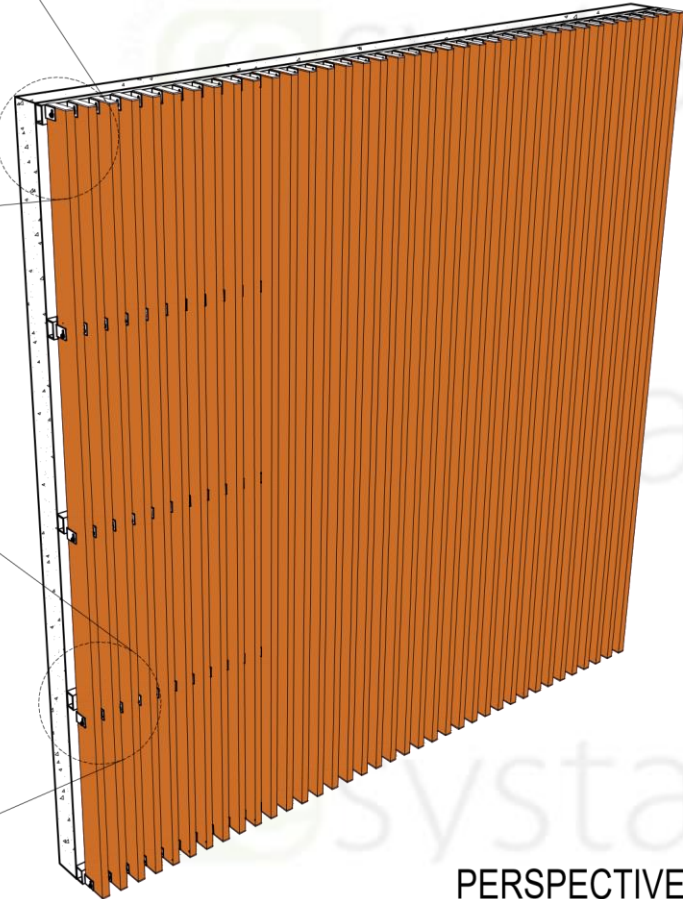

PERSPECTIVE

SUB-DETAIL
4VCUB 1.2

N.T.S

DIMENSION LEGEND	
Millimeter (mm)	
Inches (") / Foot (')	



NOTE
THIS DRAWING AS AN INSTRUMENT OF SERVICE, IS THE PROPERTY OF RESYSTA AND AS SUCH MUST NOT BE REPRODUCED OR COPIED IN PART OR IN WHOLE WITHOUT THE PERMISSION OF THE AUTHOR.

TITLE	SHEET CONTENT	CONTINENT
4CH - U BRACKET VERTICAL CLADDING SUB-DETAIL	PERSPECTIVE	RESYSTA USA
	DETAIL -1.0	
	DETAIL -2.0	
SPECIFICATION	DRAWING NO.	DATE
TYPICAL DRAWING DETAIL	4VCUB-1.2	27.02.23
	CAD BY:	CHECKED BY:
	C.R.E	

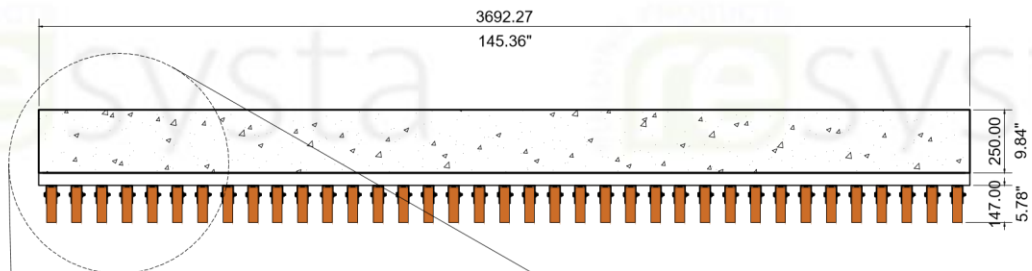

TOP VIEW

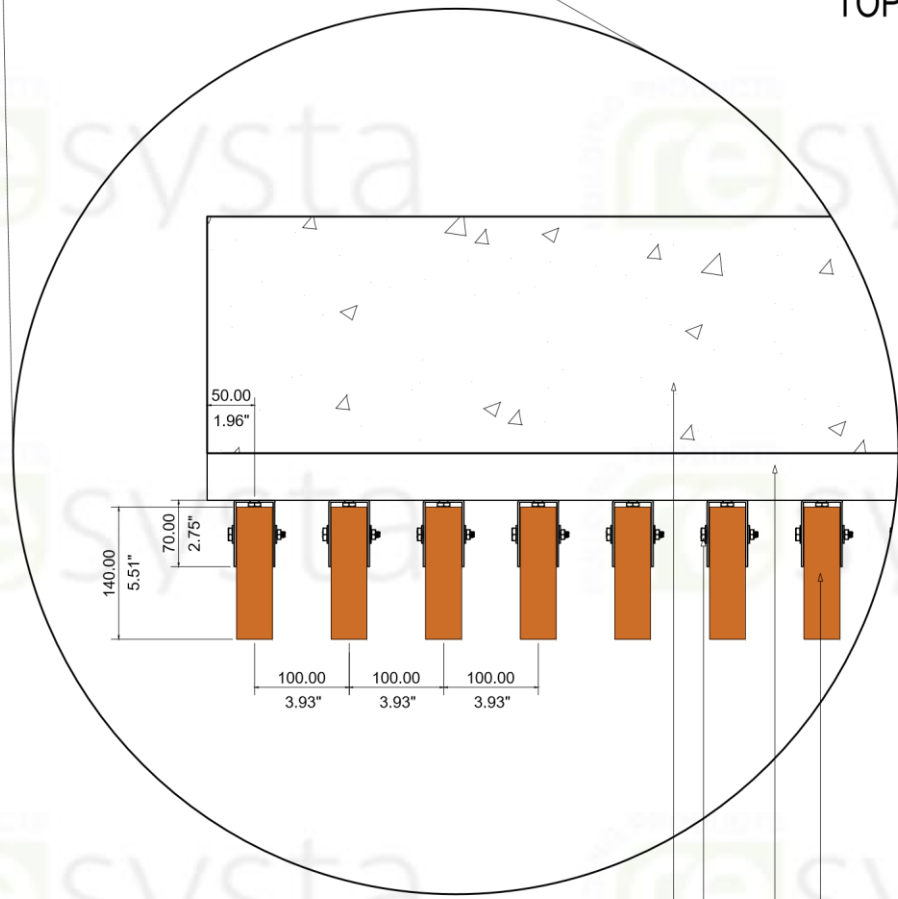

- EXISTING WALL
- RESUB112234 Aluminum U-Bracket with Bolt, washer and nut
- SUBSTRUCTURE BY OTHERS
- RESGC020612 Cladding (4CH)

DETAIL - 3.0

SUB-DETAIL
4VCUB 1.3
N.T.S

DIMENSION LEGEND	
	Millimeter (mm)
	Inches (") / Foot (')



NOTE
THIS DRAWING AS AN INSTRUMENT OF SERVICE, IS THE PROPERTY OF RESYSTA AND AS SUCH MUST NOT BE REPRODUCED OR COPIED IN PART OR IN WHOLE WITHOUT THE PERMISSION OF THE AUTHOR.

TITLE	SHEET CONTENT	CONTINENT
4CH - U BRACKET VERTICAL CLADDING SUB-DETAIL	TOP VIEW	RESYSTA USA
	DETAIL -3.0	
SPECIFICATION	DRAWING NO.	DATE
TYPICAL DRAWING DETAIL	4VCUB-1.3	27.02.23
	CAD BY:	CHECKED BY:
	C.R.E	

RESUB112234 Aluminum U-Bracket
with Bolt, washer and nut

RESCAP0206Cxx Hollow Cap

SUBSTRUCTURE BY OTHERS

RESGC020612 Cladding (4CH)

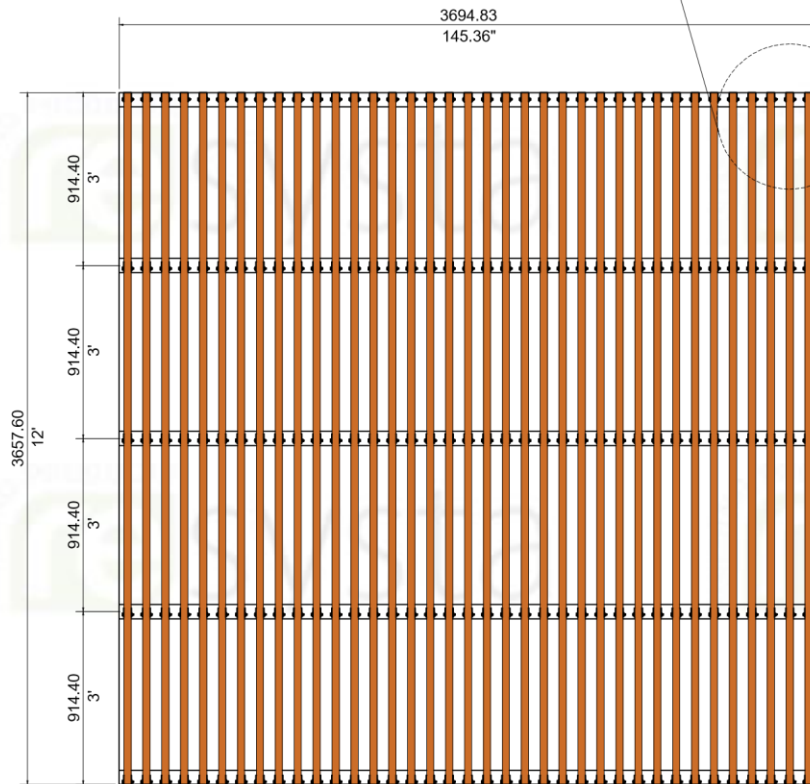
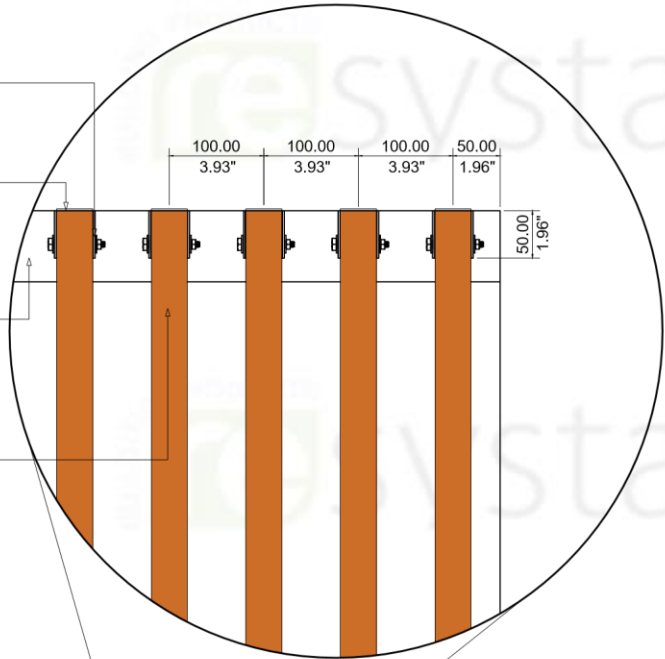

DETAIL - 4.0

FRONT ELEVATION

SUB-DETAIL
4VCUB 1.4

N.T.S

DIMENSION LEGEND

Millimeter (mm)
Inches (") / Foot (')



NOTE

THIS DRAWING AS AN INSTRUMENT OF SERVICE, IS THE PROPERTY OF RESYSTA AND AS SUCH MUST NOT BE REPRODUCED OR COPIED IN PART OR IN WHOLE WITHOUT THE PERMISSION OF THE AUTHOR.

TITLE	SHEET CONTENT	CONTINENT
4CH - U BRACKET VERTICAL CLADDING SUB-DETAIL	FRONT ELEVATION	RESYSTA USA
	DETAIL-4.0	
SPECIFICATION	DRAWING NO.	DATE
	4VCUB-1.4	27.02.23
	CAD BY:	CHECKED BY:
TYPICAL DRAWING DETAIL	C.R.E	

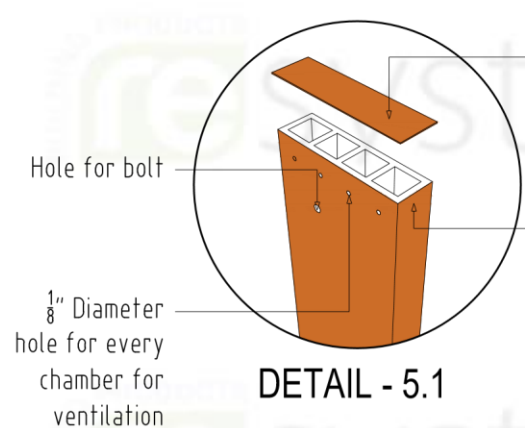

DETAIL - 5.1

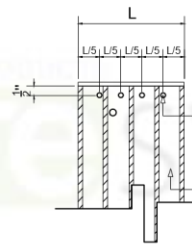

SECTION

1/8" Diameter hole for every chamber for ventilation
 RESGC020612

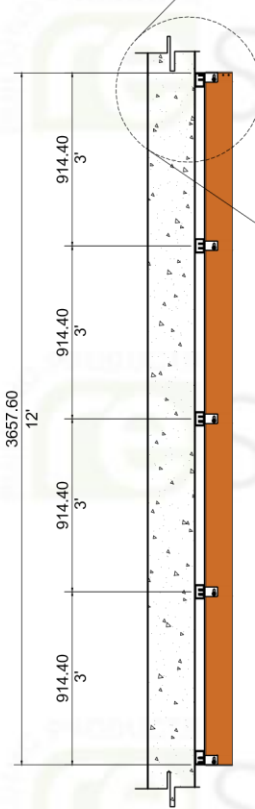

SIDE ELEVATION

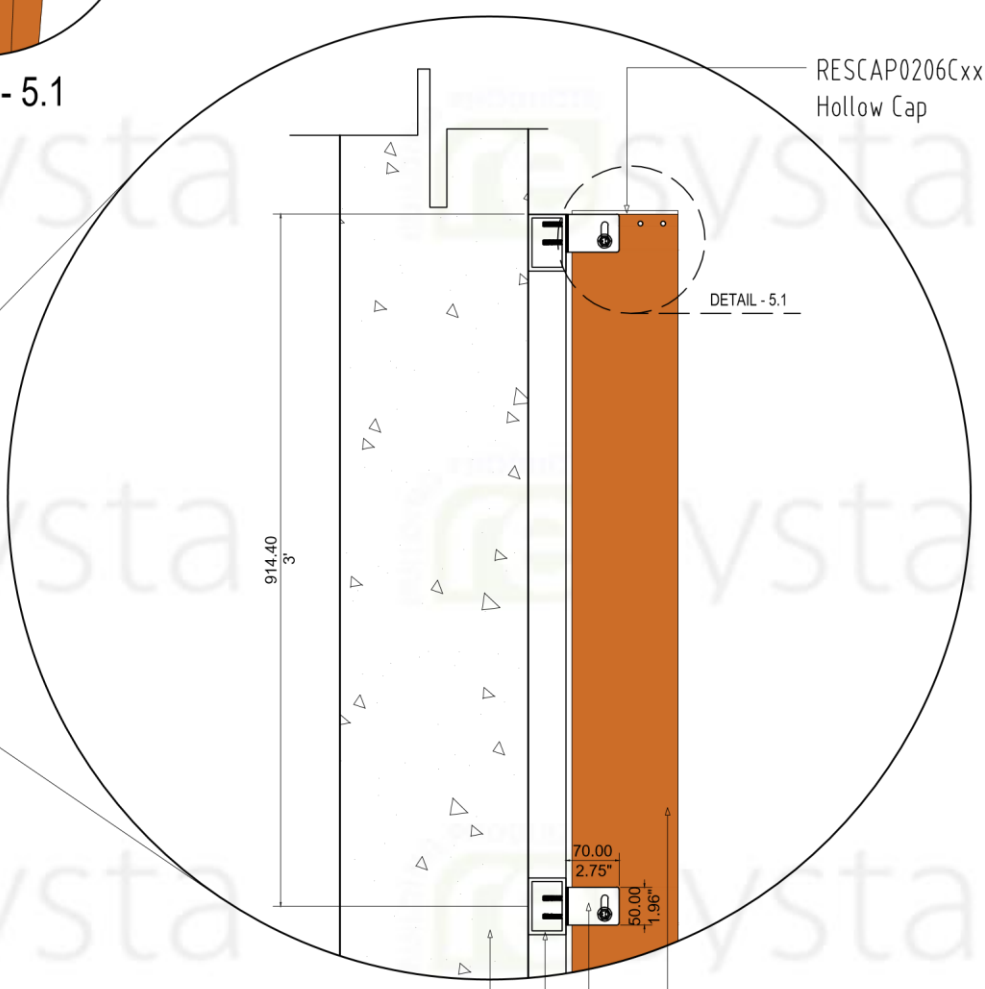

DETAIL - 5.0

SUB-DETAIL
 4VCUB 1.5

N.T.S

DIMENSION LEGEND	
Millimeter (mm)	
Inches (") / Foot (')	



NOTE
 THIS DRAWING AS AN INSTRUMENT OF SERVICE, IS THE PROPERTY OF RESYSTA AND AS SUCH MUST NOT BE REPRODUCED OR COPIED IN PART OR IN WHOLE WITHOUT THE PERMISSION OF THE AUTHOR.

TITLE	SHEET CONTENT	CONTINENT
4CH - U BRACKET VERTICAL CLADDING SUB-DETAIL	SIDE ELEVATION	RESYSTA USA
	DETAIL-5.0	
	DETAIL-5.1	
SPECIFICATION	SECTION	DATE
TYPICAL DRAWING DETAIL	DRAWING NO.	27.02.23
	CAD BY:	CHECKED BY:
	C.R.E	

