

BUILDING PRODUCTS



resysta

INSTALLATION GUIDE

RESYSTA FENCE SYSTEM



The Materials

Resysta fence is extremely resistant to outdoor / exterior influences and is 100% recyclables.

Resysta fence really looks like premium wood. Our product is distinguished by its unique structure, making it very solid. Its permeability makes it resistant to decay and all-weather conditions. Unlike wood, Resysta fence does not grey and its color fades minimally.

Once installed, your terrace will require a minimum of maintenance for a maximum of years, it is a real ecological alternative to tropical wood products.

Its use is mainly recommended outdoors for a terrace, around a swimming pool or a jacuzzi, etc. - where thermal and environmental constraints are extreme.

Resysta Fence Materials Strengths

Product Properties

- UV resistant
- Weather resistant
- Resistance to chlorine
- Resistance to insects and fungi / mold

Installation

- Easy installation
- Complete system components
- Easy to refresh color

Surface Quality

- Texture identical to wood
- No splinters
- 30 color to choose from

Durability

- Will not rot
- 100% recyclable
- Easy maintenance

Scope of Delivery

NO.	PRODUCT NAME AND SPECIFICATION	ISOMETRIC VIEW	SECTION VIEW
1	RESFP010608 3/4" x 6-3/8" x 93-1/2" Fence Profile		
2	RESFI123408 3/4" x 9/16" x 93-3/4" Profile Insert		
3	RESFPB11416 16" x 1-1/4" x 6" x 1/2" Fence Post Base		
4	RESFP04040 3-3/4" x 3-3/4" x 72" Fence Post with Insert Profile		
5	RESFB3411208 3/4" x 1-1/4" x 93-3/4" Fence Bottom Rail		
6	RESFT3411208 1/2" x 3/4" x 93-3/4" Fence Top Rail		
7	RESFC0404 3-3/4" x 3-3/4" Fence Post Cap		

Table 1.1 "Scope of Delivery"

NOTE:

To view a complete list of products, please refer to our Resysta brochure or visit our website www.resystausa.com.

Resysta Fence



ISOMETRIC VIEW

Step 1

To install the fence, first verify the floor level and the design or layout of the fence. Next, securely install the RESFPB11416 fence post base onto the concrete base using a recommended M10 bolt with a washer. Ensure that each fence post base is positioned 96" apart at the center.

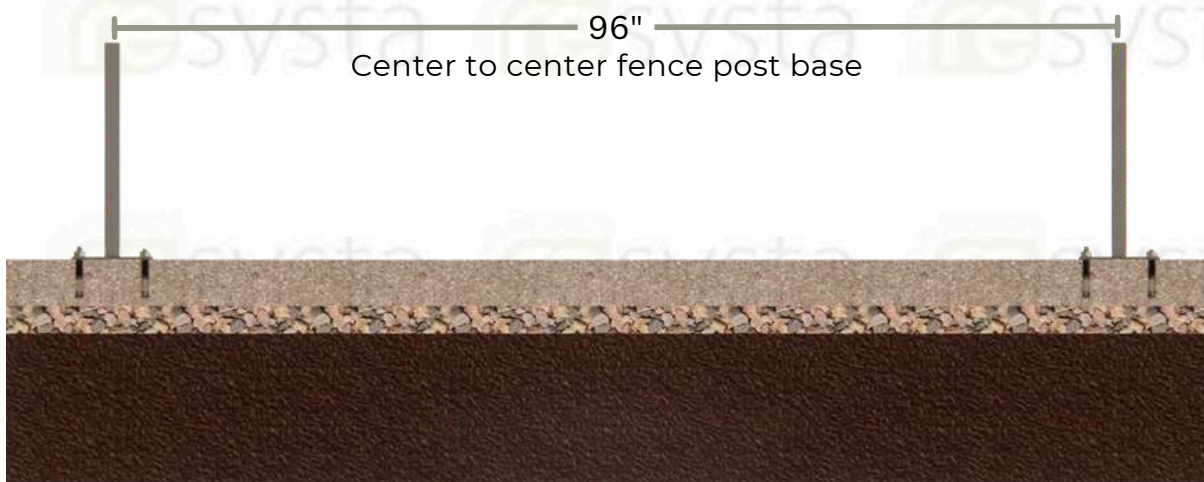

SECTION
Fence System

RESFPB11416
Fence Post Base
Recommended
bolt and nut
supply by others **M10**



ISOMETRIC DETAIL
Fence System



ISOMETRIC VIEW
Fence System

Step 2

Insert fence post RESFP04040 into the RESFPB11416 fence post base.

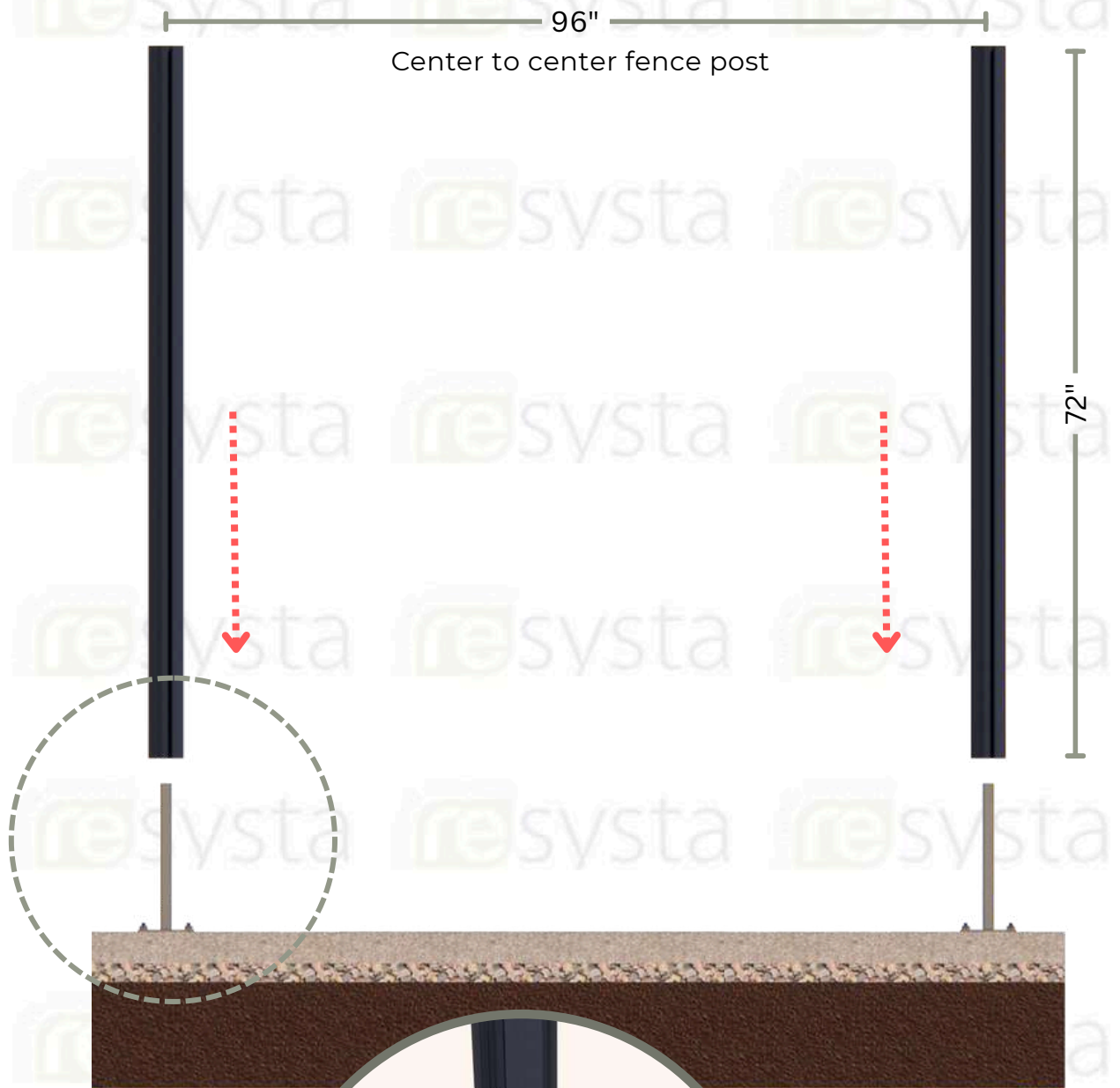

RESFP04040
Fence Post

RESFPB11416
Fence Post Base

SECTION
Fence System



ISOMETRIC DETAIL
Fence System

Step 3

Ensure that you create both top and bottom holes on the fence post RESFP04040 and the RESFPB11416 fence post base. The holes will be drilled on-site to meet the specific conditions of the project.



ELEVATION
Fence System

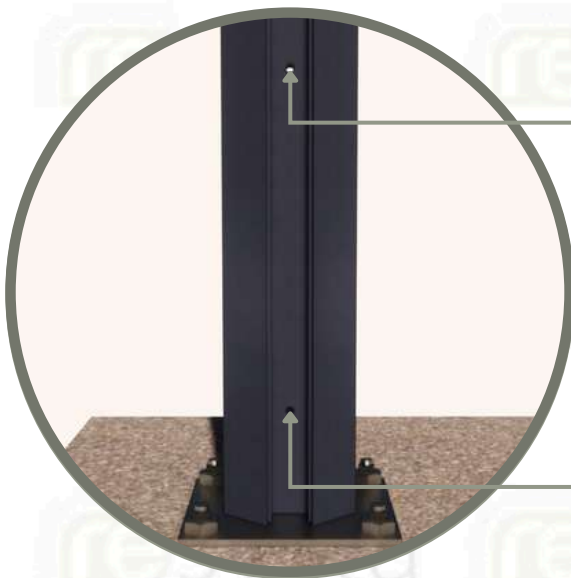

ISOMETRIC DETAIL
Fence System

Top Part
1/4"-20 x 2"
bolt and nut

Bottom Part
1/4"-20 x 2"
bolt and nut



Step 4

Install the fence post RESFP04040 along with the fence post base using 1/4"-20 x 2" bolts and nuts. Fasten them in both the top and bottom holes, making sure the bolts extend through to the opposite side of the fence post groove.



Step 5

To ensure the proper installation of the fence board and minimize the post groove opening, simply slide the fence insert profile into place where the board will be installed.

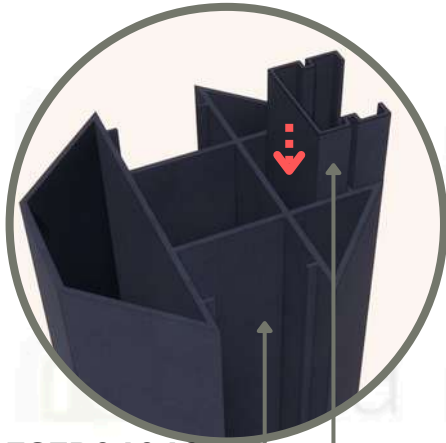

RESFP04040

Fence Post

Fence Post Insert
Profile

ISOMETRIC DETAIL

Fence System

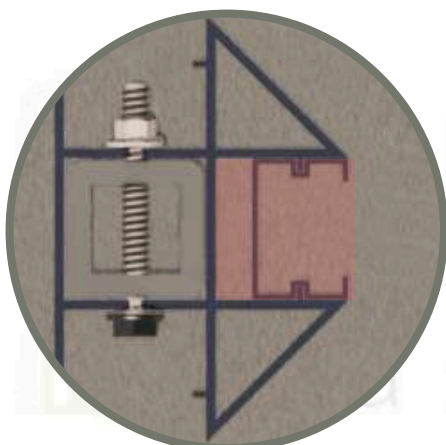
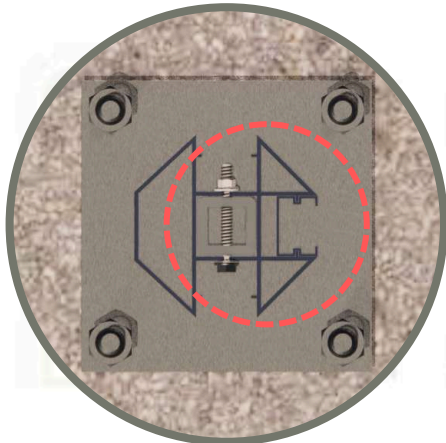

**TOP VIEW
DETAIL**

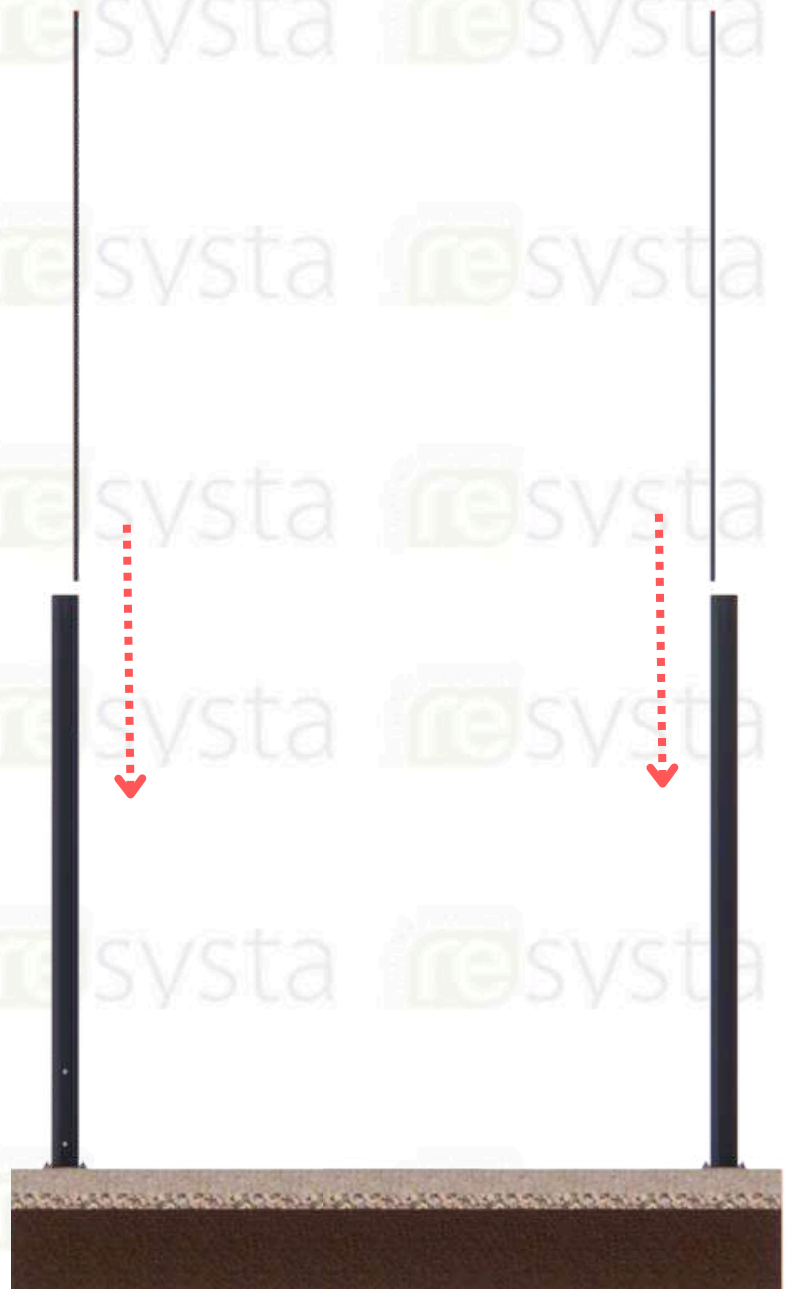

ELEVATION

Fence System

Step 5

To install the fence bottom rail of the fence, gently slide it into the groove with the fence insert profile of the RESFP04040 until it reaches the fence post base.

RESFB3411208
Fence Bottom Rail

RESFP04040
Fence Post with
Insert Profile

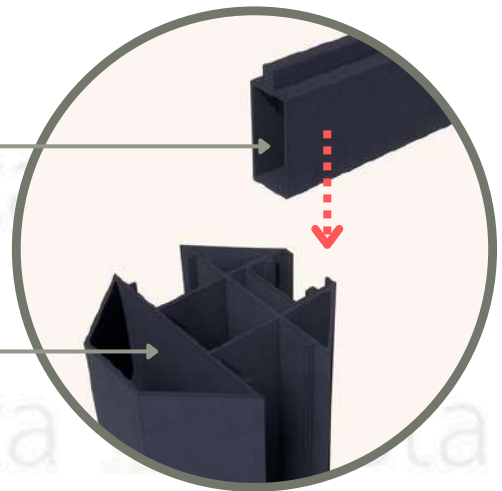

ISOMETRIC DETAIL
Fence System

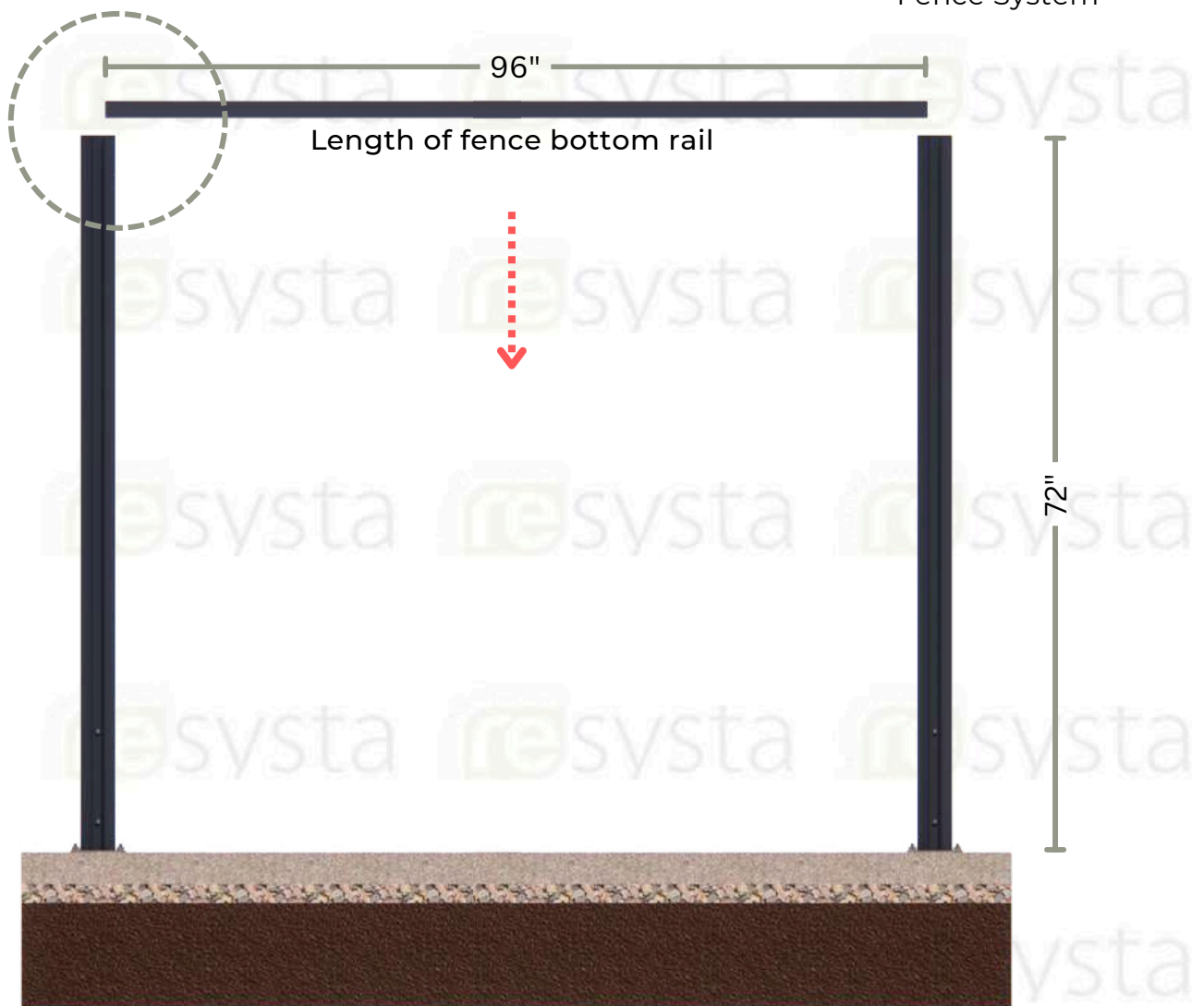

ELEVATION
Fence System



ELEVATION
Fence System



ISOMETRIC DETAIL
Fence System

RESFP04040
Fence Post with
Insert Profile

RESFB3411208
Fence Bottom Rail

RESFPB11416
Fence Post Base

Step 6

After you've installed the fence bottom rail, you can move on to installing the fence profile RESFP010608. To accomplish this, just slide the fence profile RESFP010608 into the grooves where the post fence insert profile is positioned. Ensure it is aligned with both fence posts until it fits securely against the fence bottom rail.

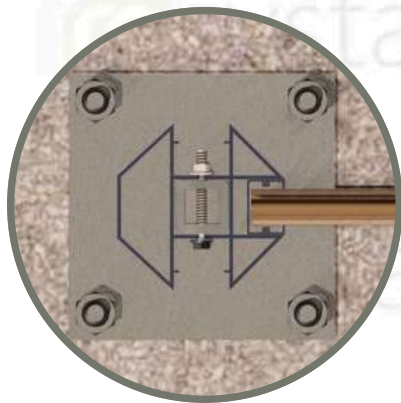

TOP VIEW
DETAIL

RESFI123408
Profile Insert

RESFP010608
Fence Profile

RESFP04040
Fence Post with
Insert Profile



ISOMETRIC DETAIL
Fence System

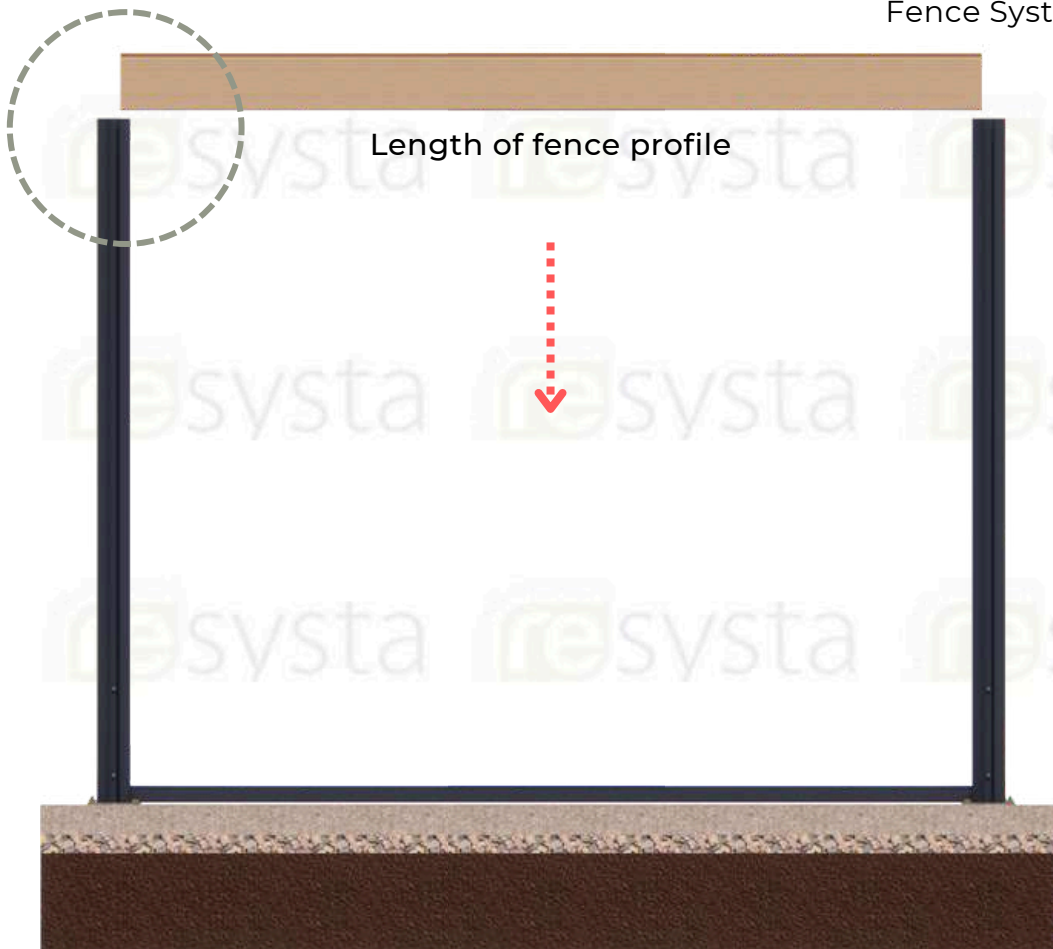

Length of fence profile

SECTION
Fence System



96"
Center to center fence post

72"

ELEVATION
Fence System



RESFP04040
Fence Post

RESFP010608
Fence Profile

RESFB3411208
Fence Bottom Rail

RESFPB11416
Fence Post Base

ISOMETRIC DETAIL
Fence System

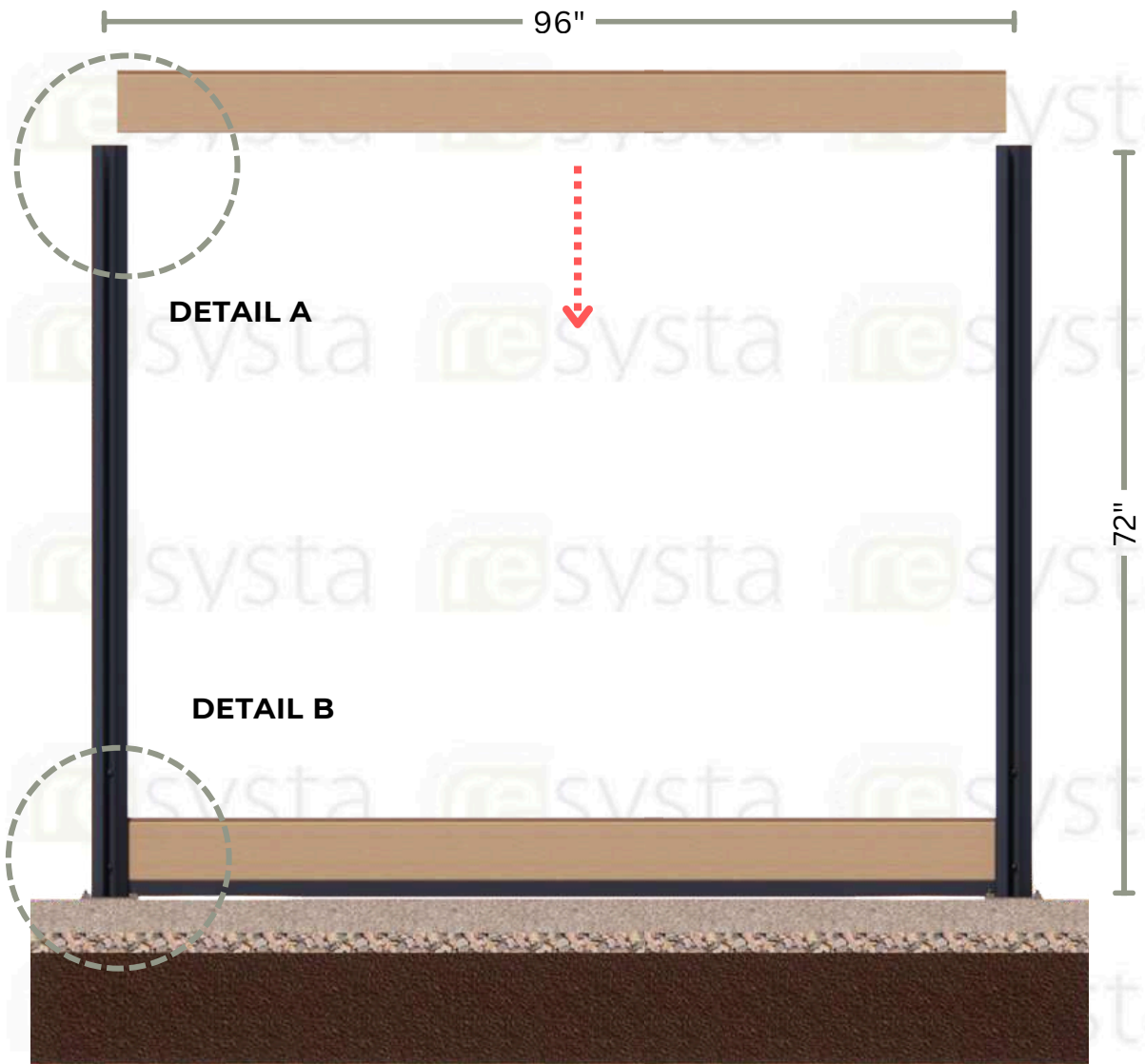

ELEVATION
Fence System

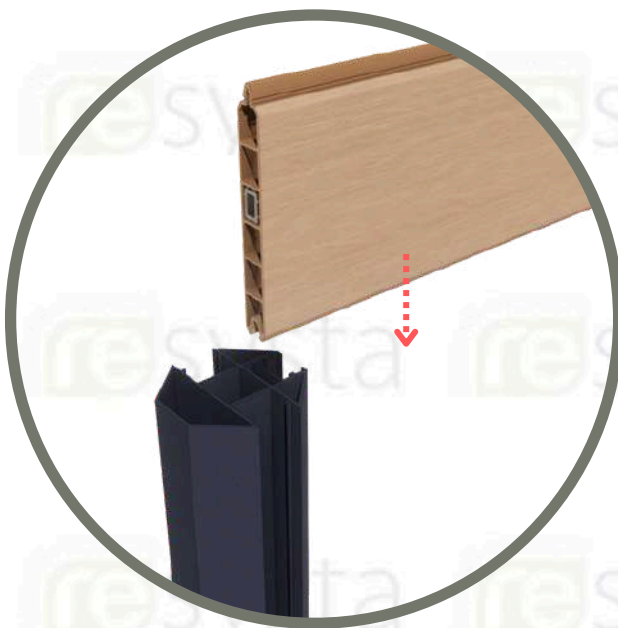

ISOMETRIC DETAIL A
Fence System



ISOMETRIC DETAIL B
Fence System



ELEVATION
Fence System



RESFP04040
Fence Post with Insert

RESFP010608
Fence Profile

RESFB3411208
Fence Bottom Rail

RESFPB11416
Fence Post Base

ISOMETRIC DETAIL
Fence System

Step 7

Continue with the installation of the fence profile RESFP010608 by adhering to step 6 until you reach the final top board.

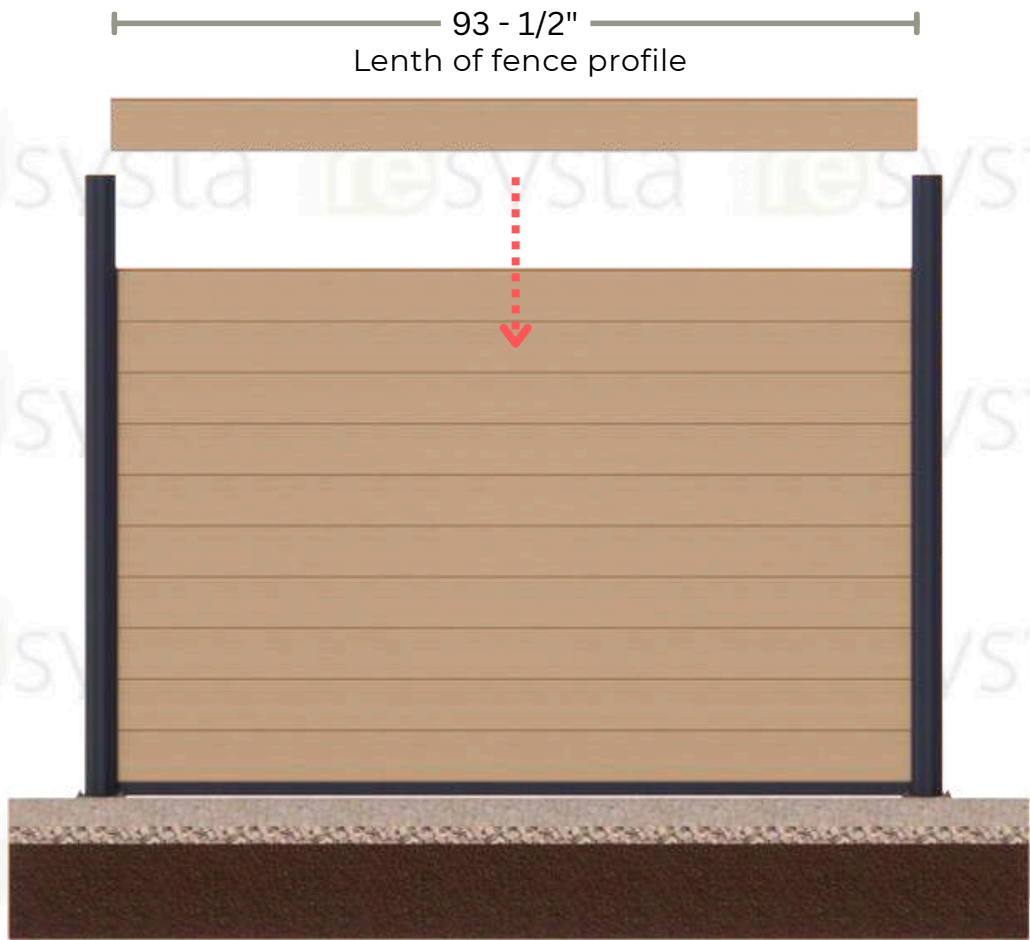

ELEVATION
Fence System

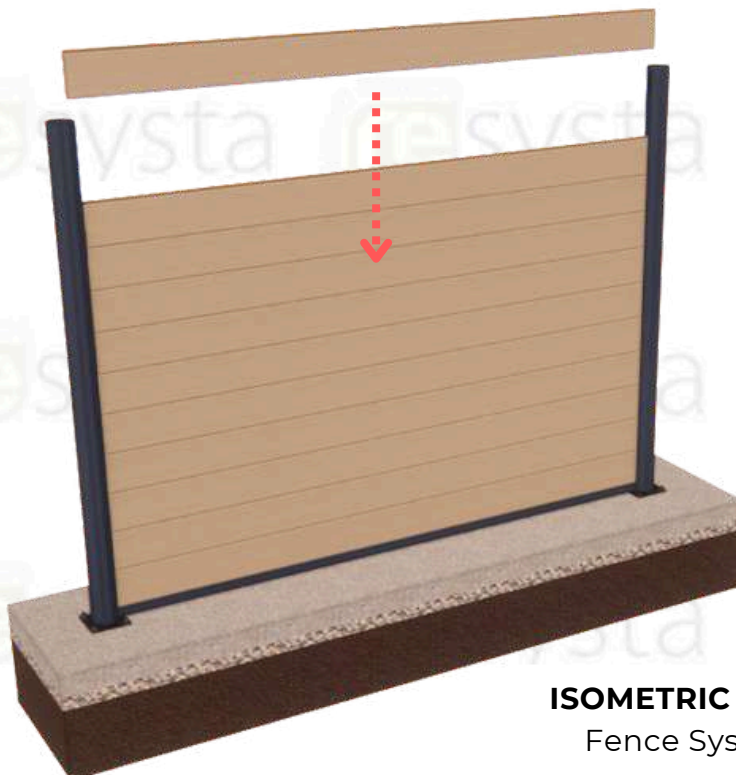

ISOMETRIC VIEW
Fence System

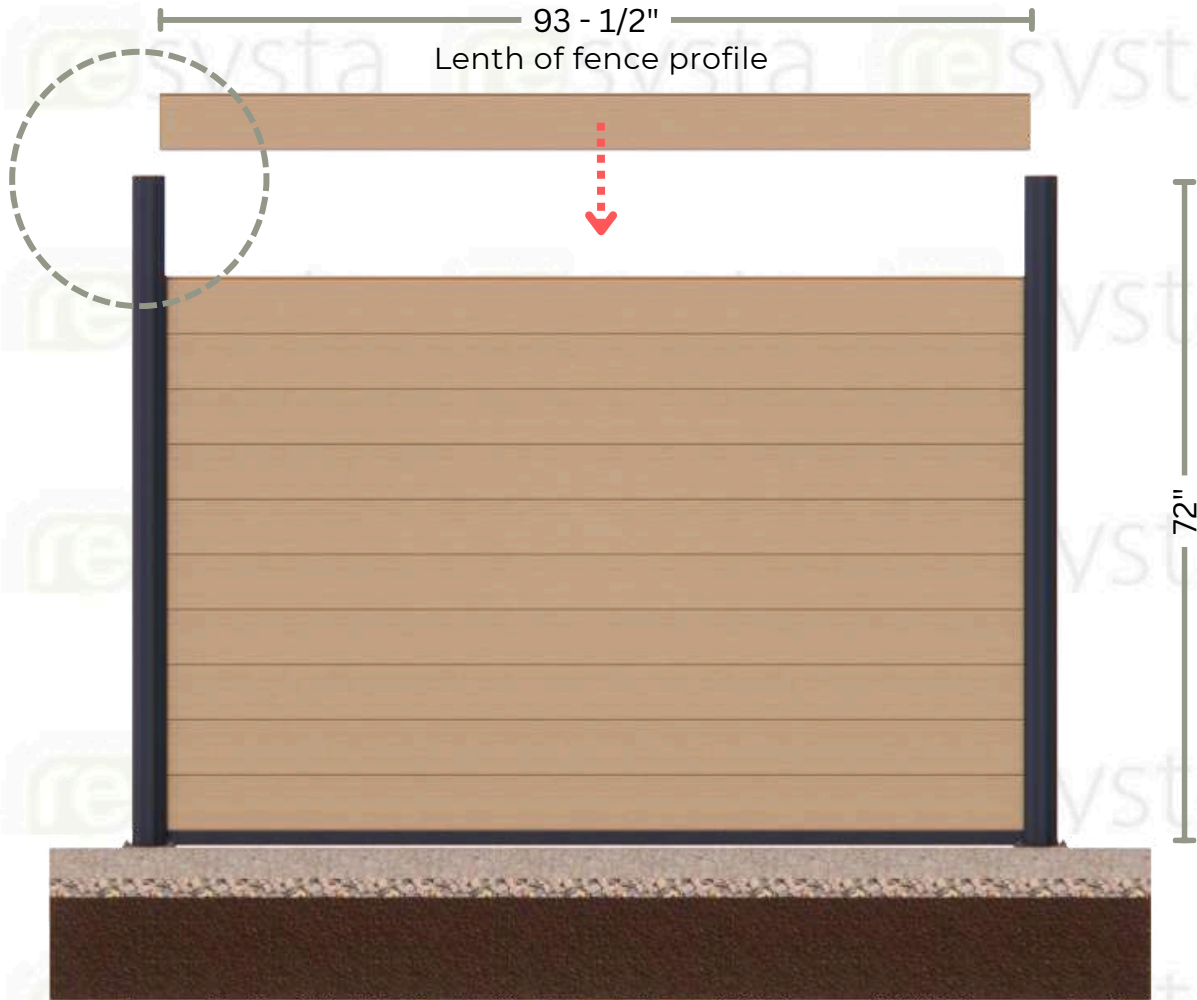

ELEVATION
Fence System

RESFI123408
Profile Insert

RESFP010608
Fence Profile

RESFP04040
Fence Post
with Insert



ISOMETRIC DETAIL
Fence System

Step 8

After securing the final profile, gently slide the post solar fence insert profile down on either side of the fence post groove from top to bottom.

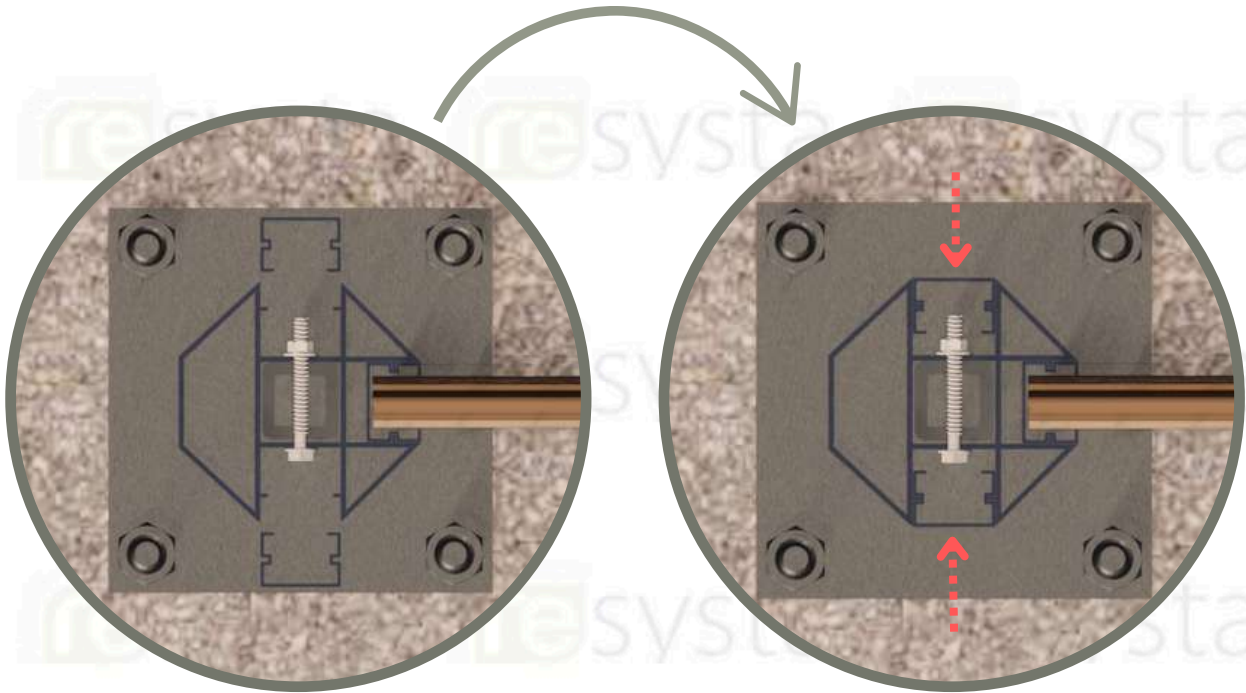

TOP VIEW - SECTION A
Fence System

TOP VIEW - SECTION B
Fence System

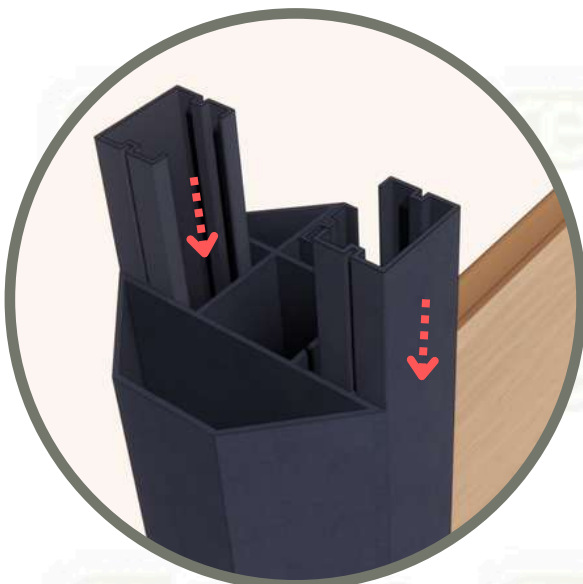

ISOMETRIC DETAIL A
Fence System



ISOMETRIC DETAIL B
Fence System

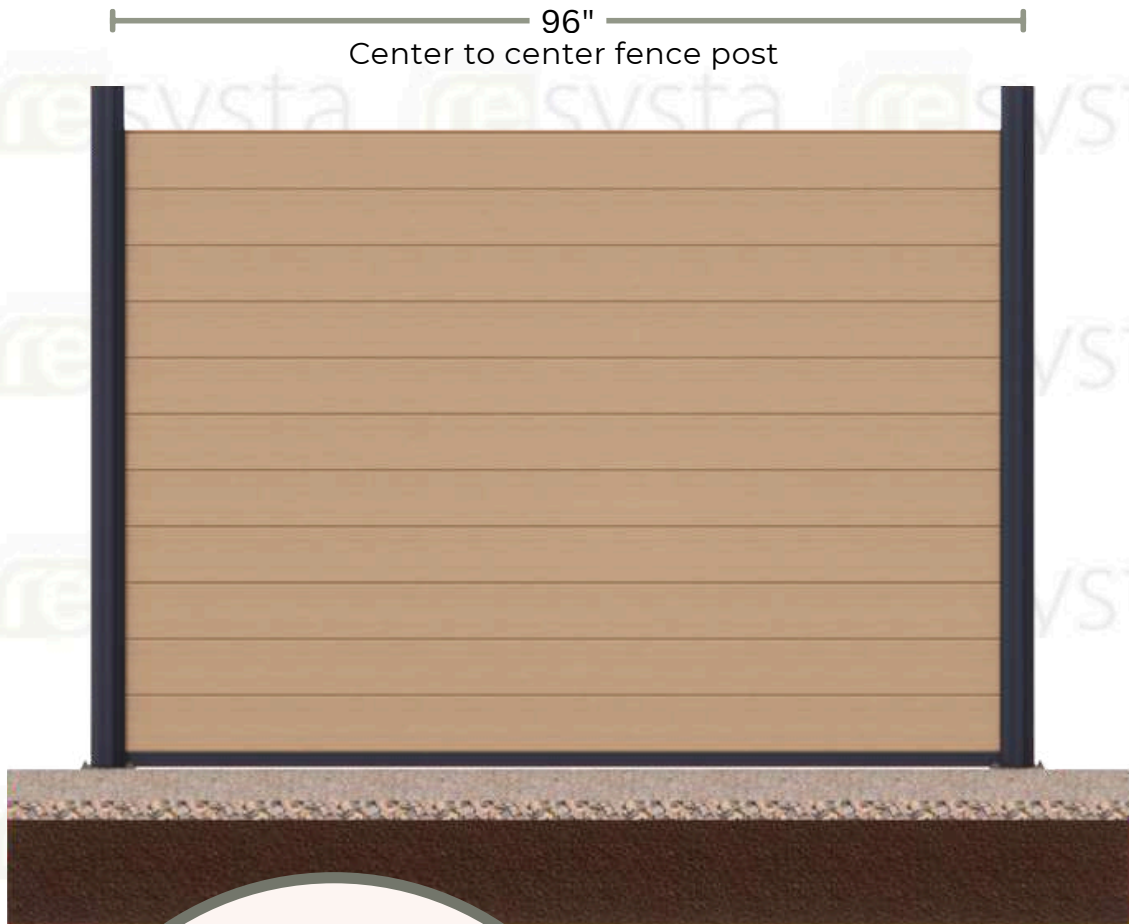

ELEVATION
Fence System



RESFP04040
Fence Post

Fence Post Insert

RESFP010608
Fence Profile

ISOMETRIC DETAIL
Fence System



ISOMETRIC VIEW
Fence System

Step 9

Then, proceed to install the fence top rail, completing the process by securing the RESFP010608 fence profile.

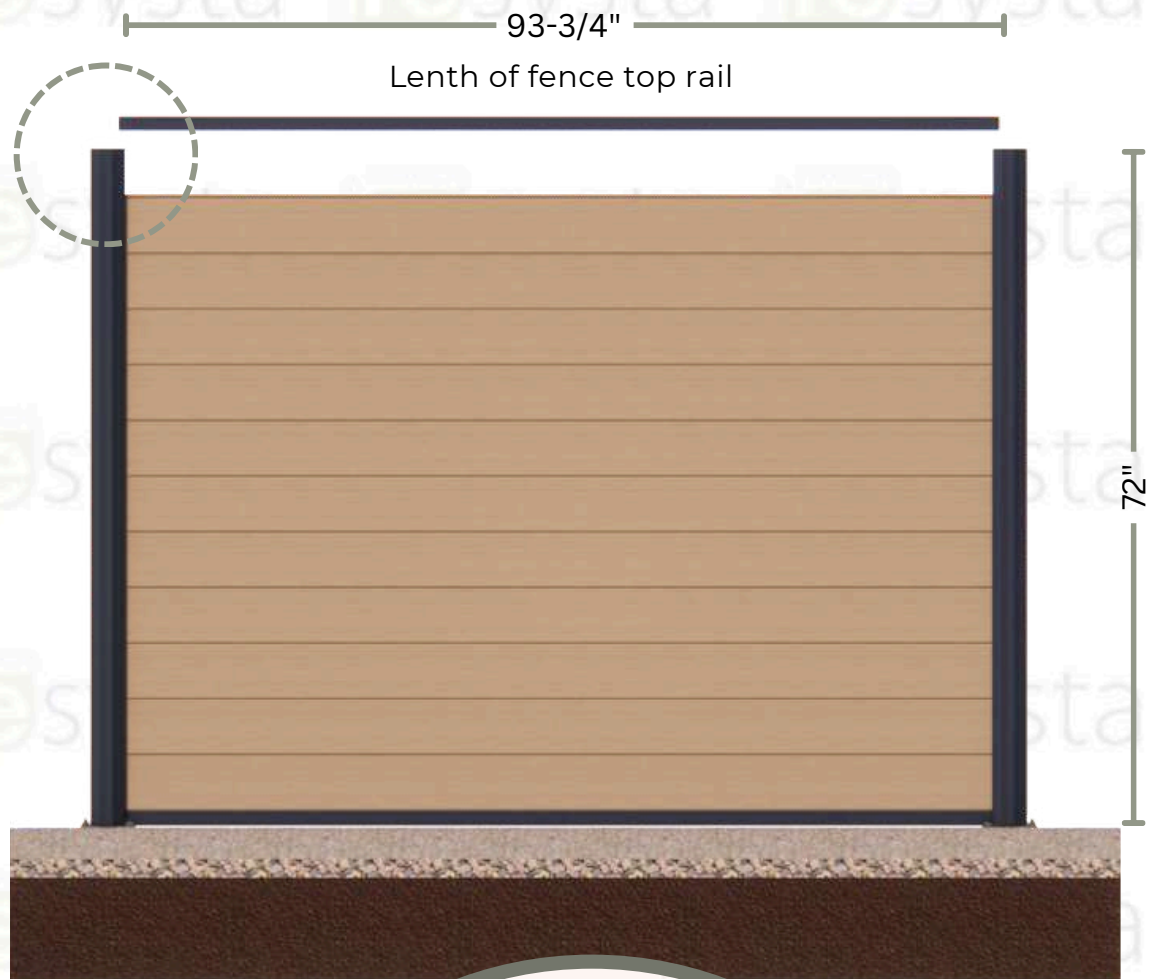

ELEVATION
Fence System

RESFT3411208
Fence Top Rail

Fence Post Insert

RESFP04040
Fence Post

RESFP010608
Fence Profile

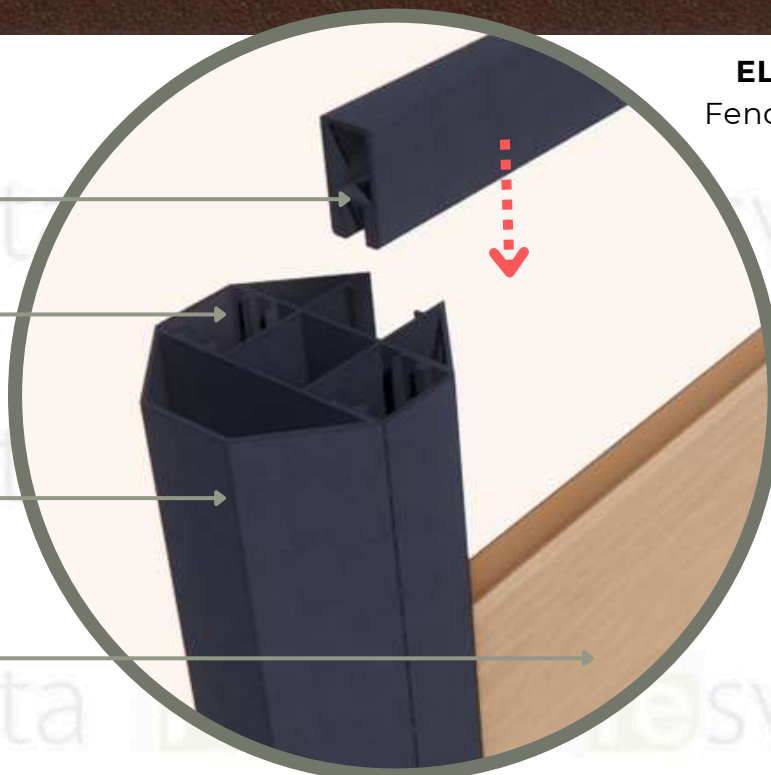

ISOMETRIC DETAIL
Fence System

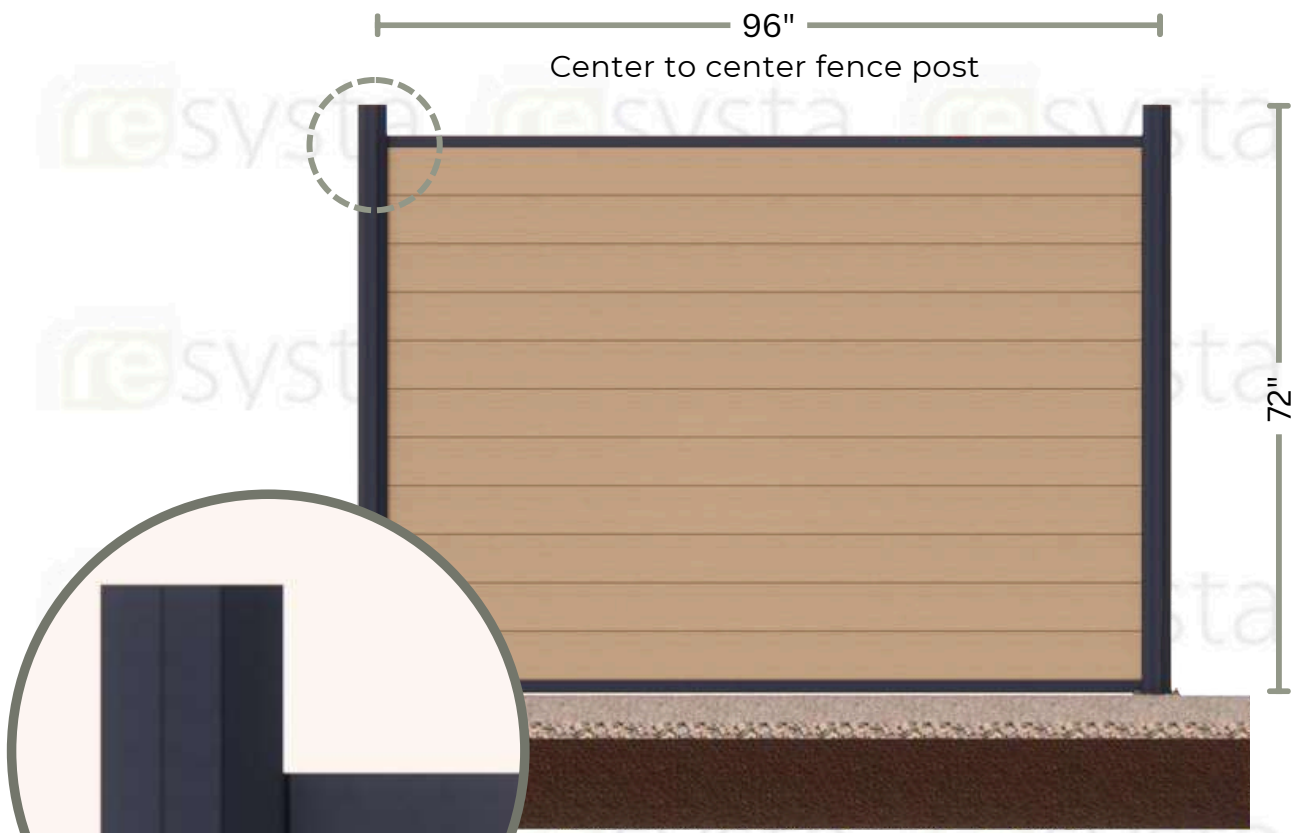

96"
Center to center fence post

72"

ELEVATION
Fence System



DETAIL
Fence System

RESFT3411208
Fence Top Rail

RESFP04040
Fence Post

RESFP010608
Fence Profile

Fence Post Insert

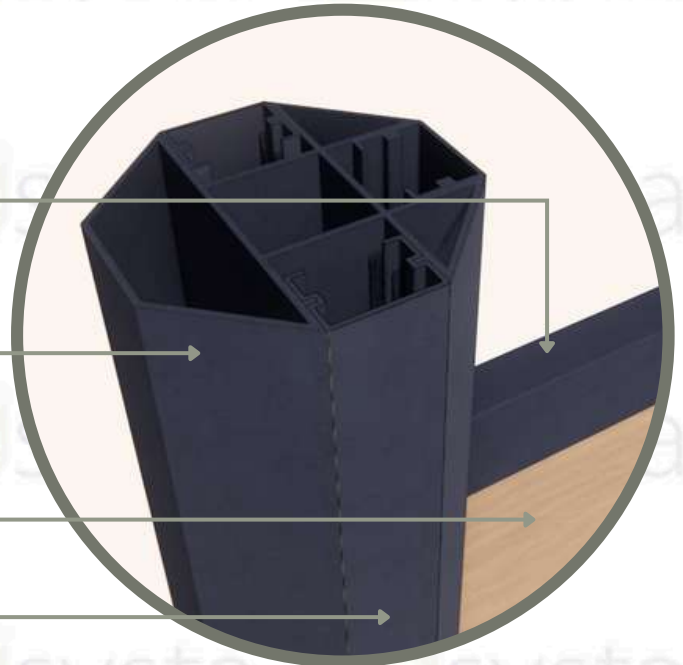

ISOMETRIC DETAIL
Fence System

Step 10

Finally, attach the fence post cap to both fence posts RESFP04040.

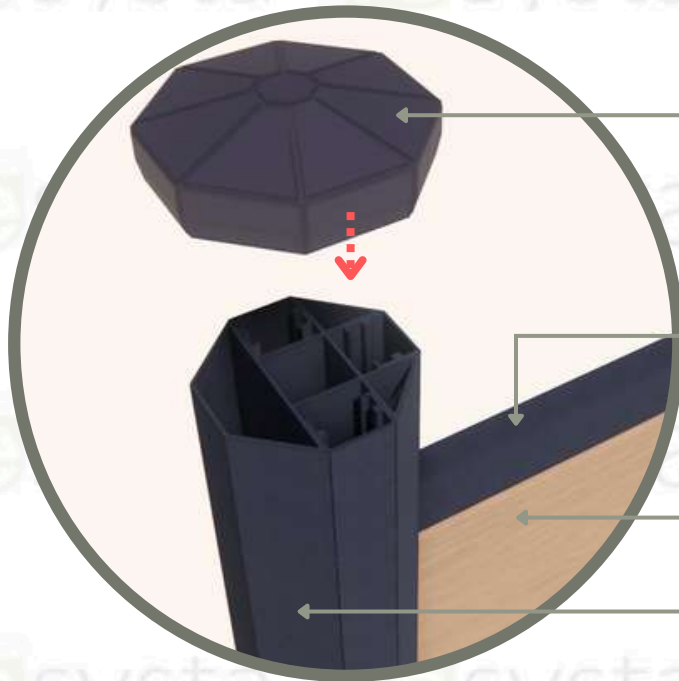

RESFC0404

Fence Post Cap

RESFT3411208

Fence Top Rail

RESFP010608

Fence Profile

RESFP04040

Fence Post with Insert

ISOMETRIC DETAIL

Fence System

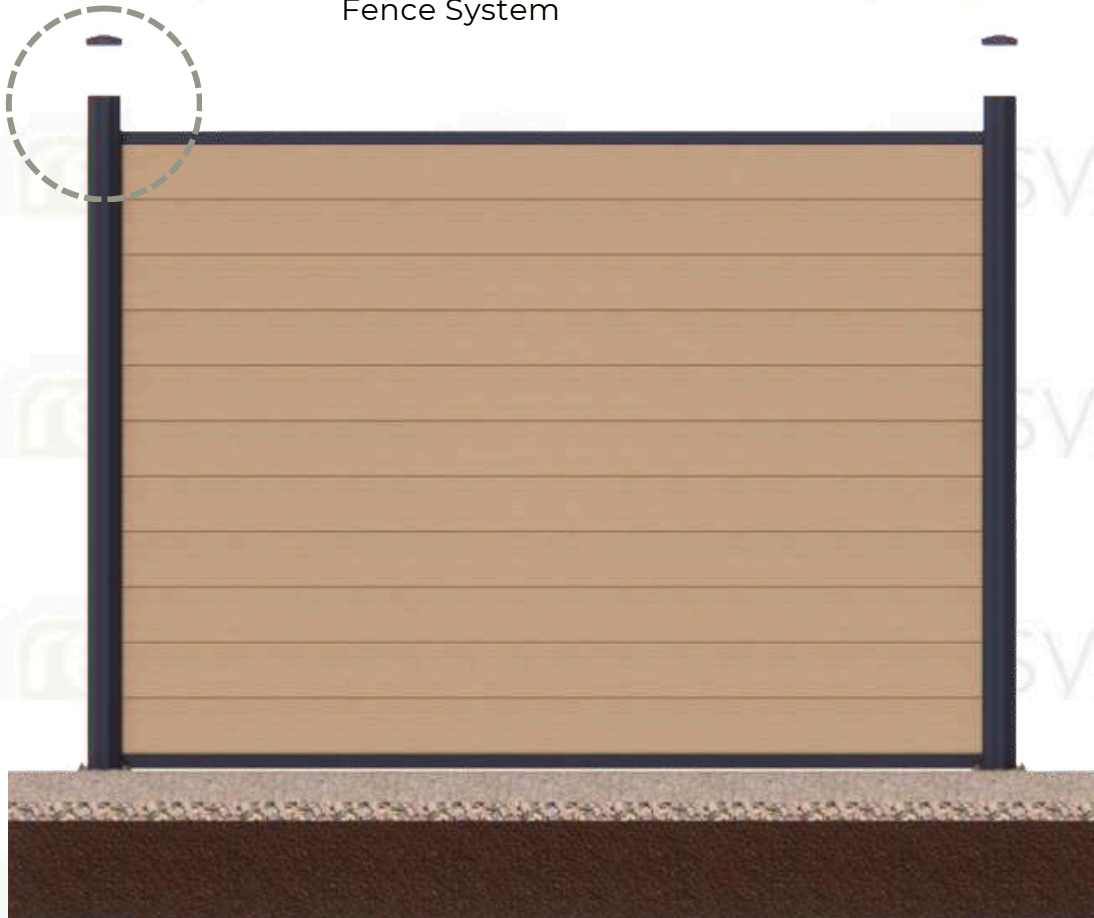

ELEVATION

Fence System

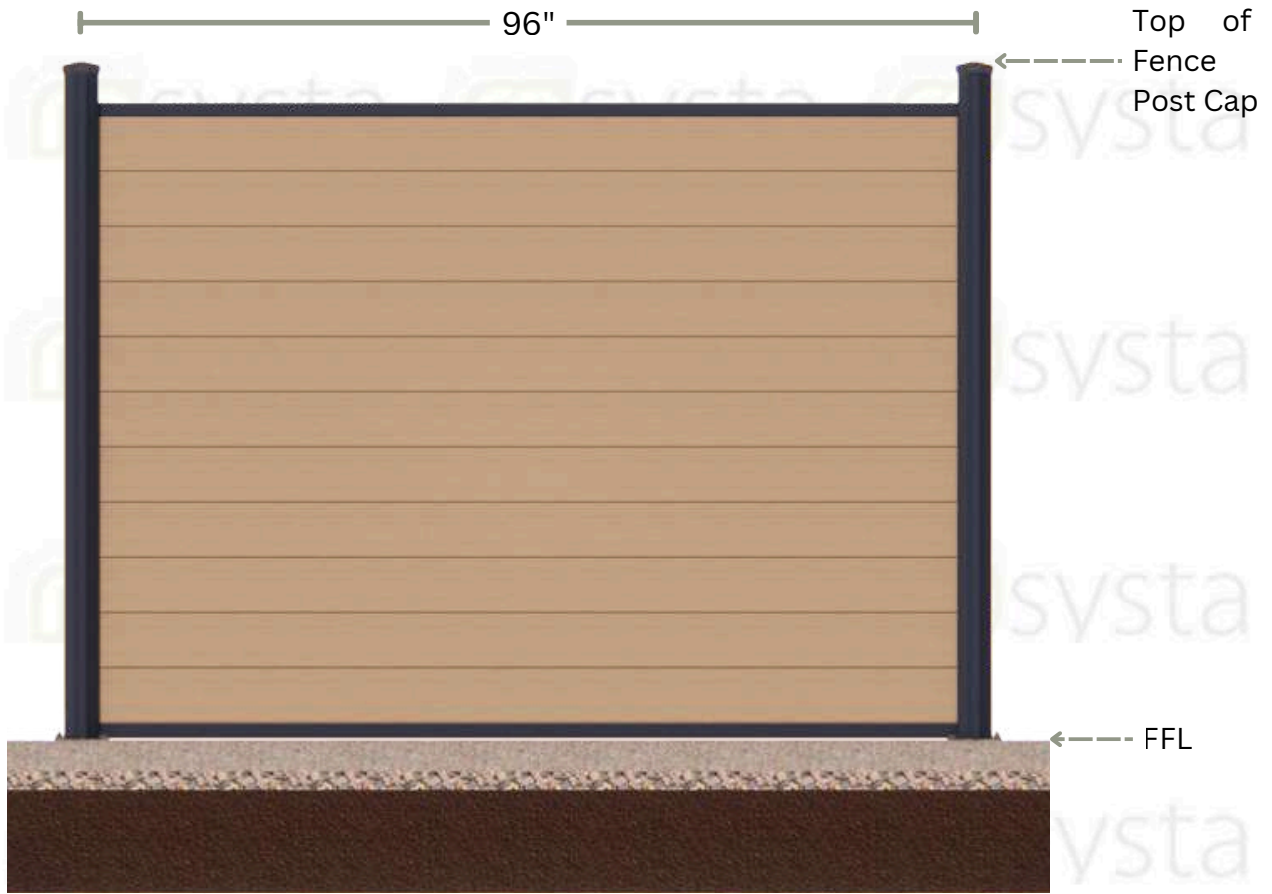

ELEVATION
Fence System

RESFP010608
Fence Profile

RESFT3411208
Fence Top Rail

RESFP04040
Fence Post w/ Insert

RESFC0404
Fence Post
Cap



ISOMETRIC DETAIL
Fence System



ISOMETRIC VIEW
Fence System

RESFT3411208

Fence Top Rail

RESFI123408

Profile Insert

RESFP010608

Fence Profile



ISOMETRIC DETAIL A

Fence System

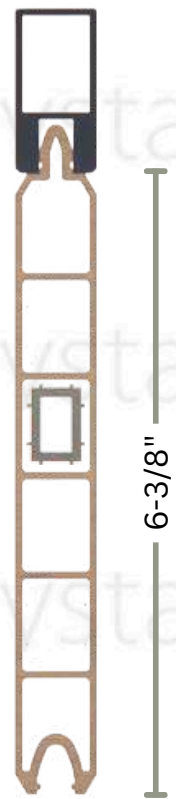

6-3/8"

6-3/8"

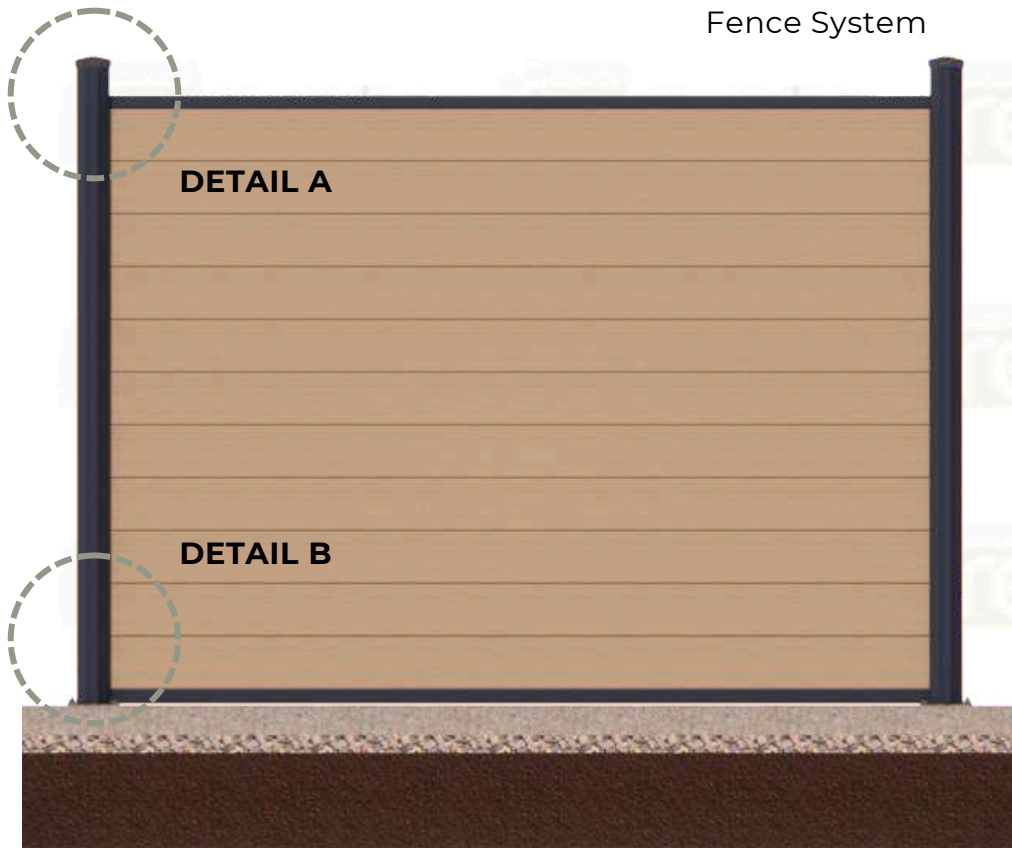

DETAIL A

DETAIL B

ELEVATION

Fence System

RESFI123408

Profile Insert

RESFP010608

Fence Profile

RESFB3411208

Fence Top Rail



ISOMETRIC DETAIL B

Fence System

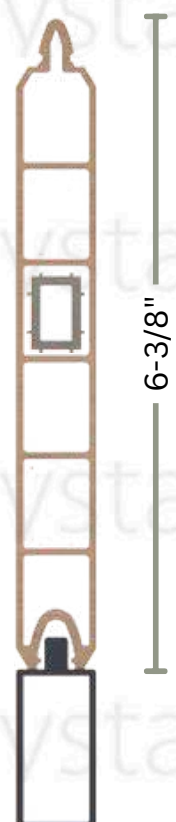

FENCE CONNECTION DETAILS

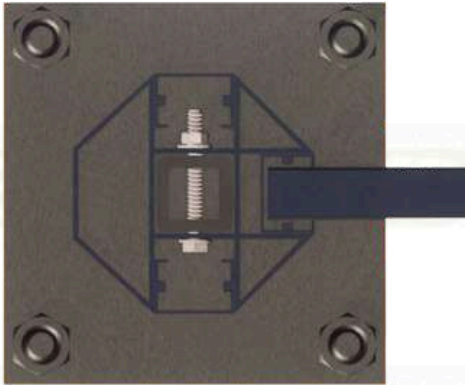

TOP VIEW
End Detail



ISOMETRIC VIEW
End Detail

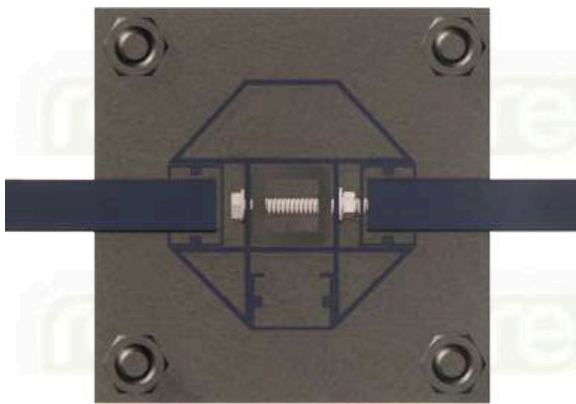

TOP VIEW
Linear Detail

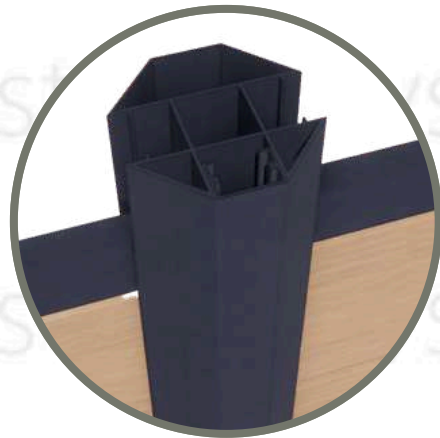

ISOMETRIC VIEW
Linear Detail

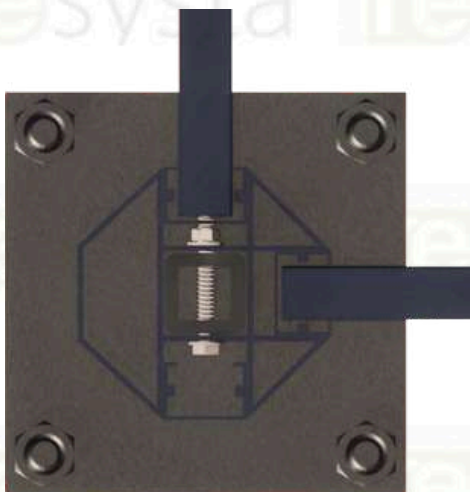

TOP VIEW
Corner Detail



ISOMETRIC VIEW
Corner Detail

Fence Installation on a Slope

When dealing with a gradual slope, consider using a stepped fence method. This approach allows you to follow the terrain while maintaining a fairly consistent gap at the bottom of the fence. In this design, each fence panel between the posts is adjusted higher or lower than the adjacent panel, conforming to the land's slope.

STEP 1 - In the change of the ground height, use a leveling line to determine the exact elevation of the fence post insert, then cut it accordingly. This fence post insert will act as the foundation for the fence bottom rail. After that, install the left-cut fence post insert, ensuring it is positioned in a reverse orientation.

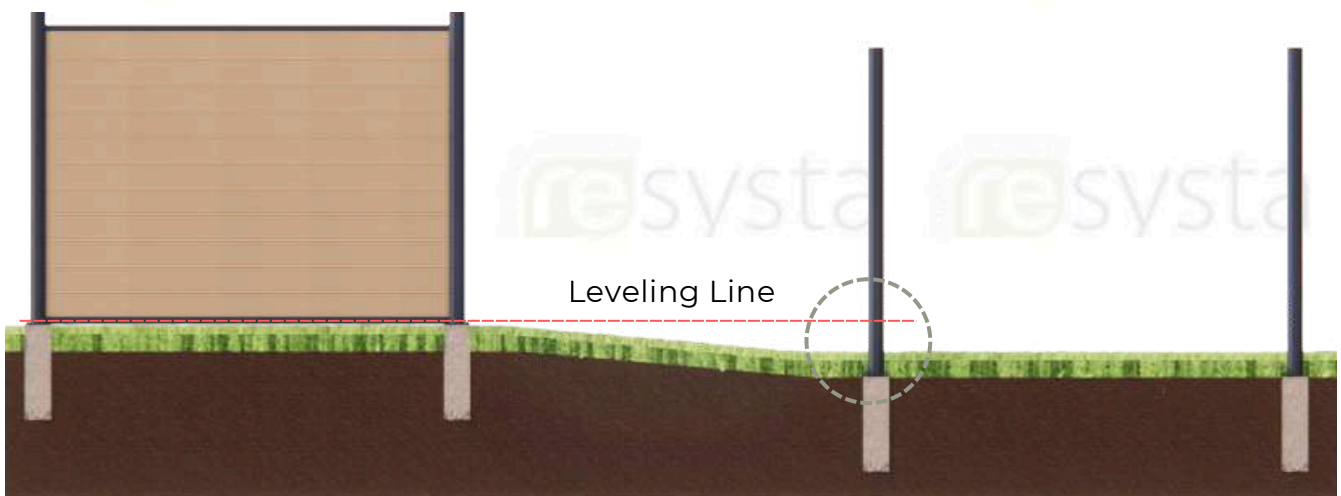

ELEVATION
Fence System

Cut Fence
Post Insert
based on the
Leveling Line

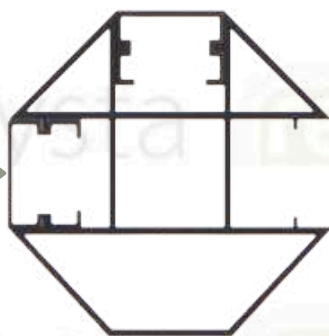

PLAN
Fence System

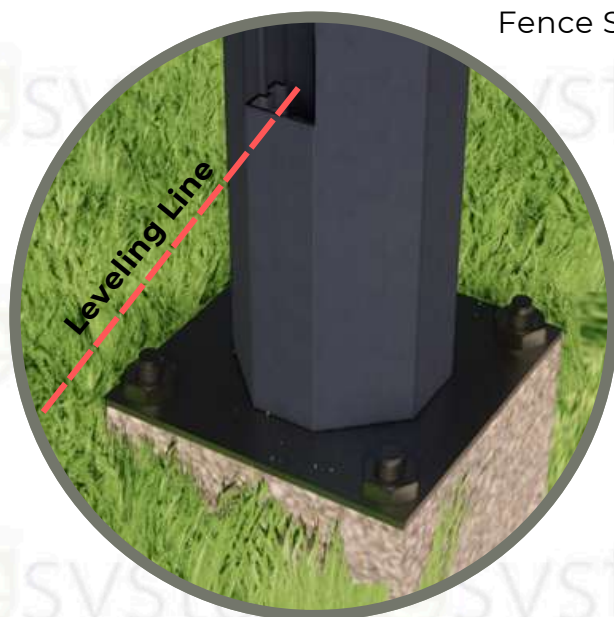

ISOMETRIC DETAIL
Fence System

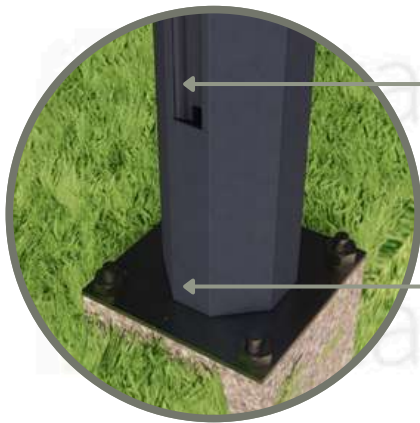

Reverse Left-Cut
Fence Post Insert

Cut Fence Post
Insert based on the
Leveling Line

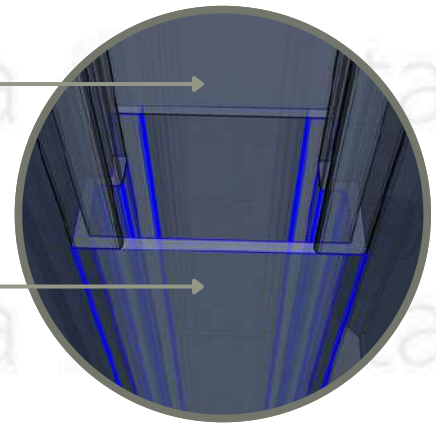

ISOMETRIC DETAIL
Fence System

ISOMETRIC DETAIL
Fence System

STEP 2 - Install the fence bottom rail that is sited on the cut fence post insert.

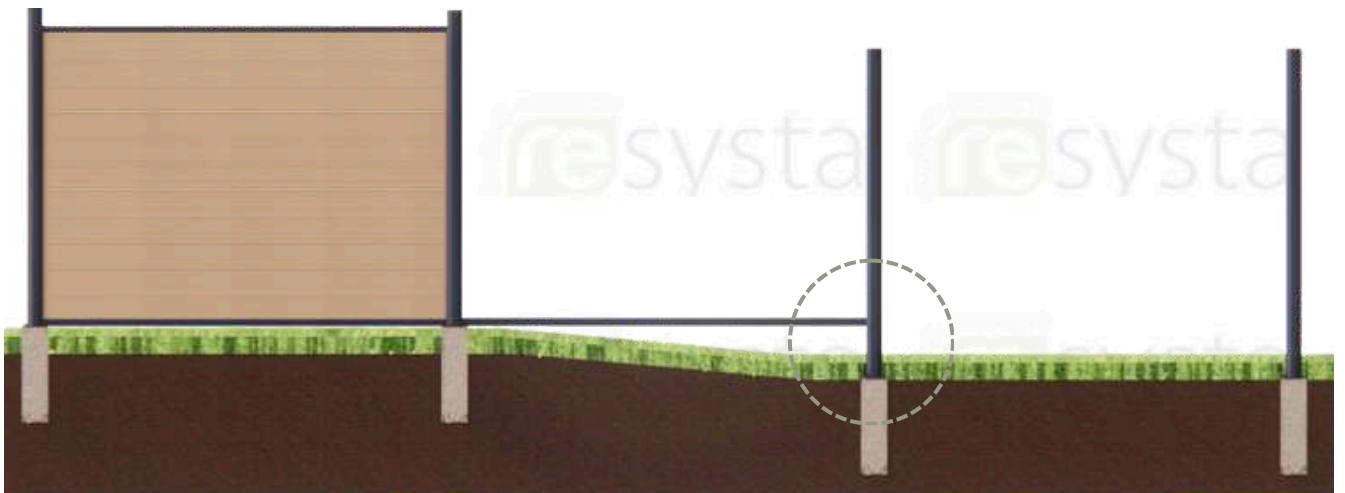

RESFB3411208
Fence Bottom Rail

ELEVATION
Fence System

Cut Fence Insert based
on the Leveling Line

RESFP04040
Fence Post

RESFPB11416
Fence Post Base

ISOMETRIC DETAIL
Fence System

STEP 3 - After installing the entire fence profile RESFP010608, make sure it is firmly secured with the fence top rail.

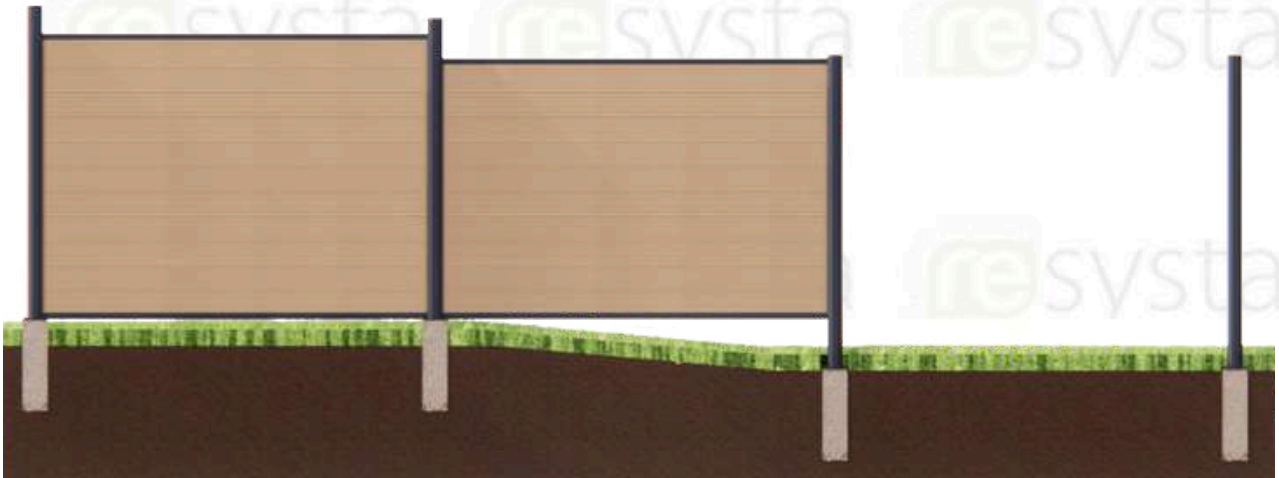

ELEVATION
Fence System

STEP 4 - Continue all the installation of the board until the end of fence layout.

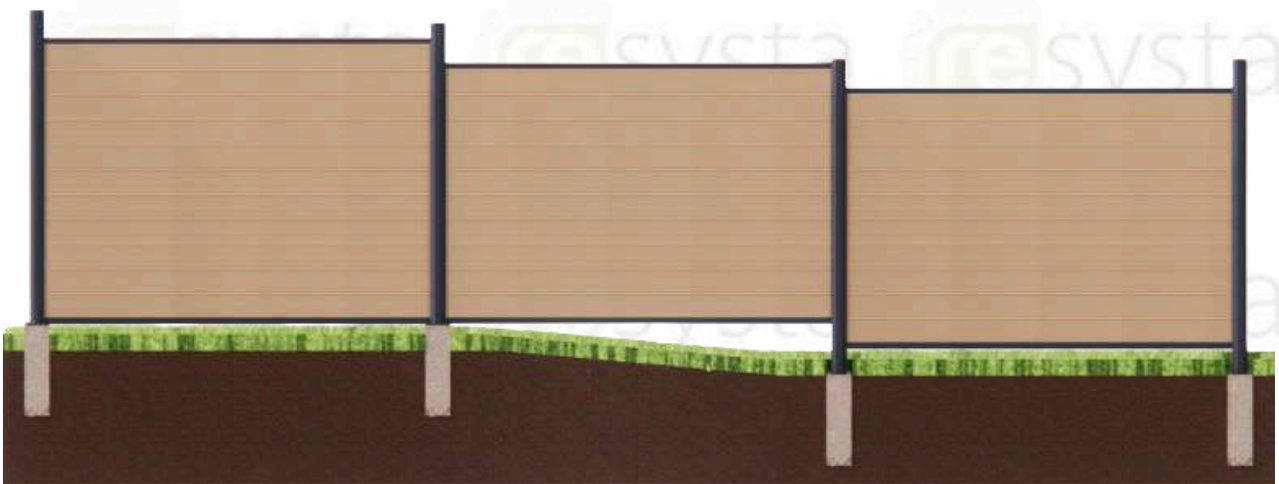

ELEVATION
Fence System

STEP 5 - To finalize the installation, cut the second fence post insert to the correct length and carefully slide it into the groove. Once that's done, attach the fence post cap.

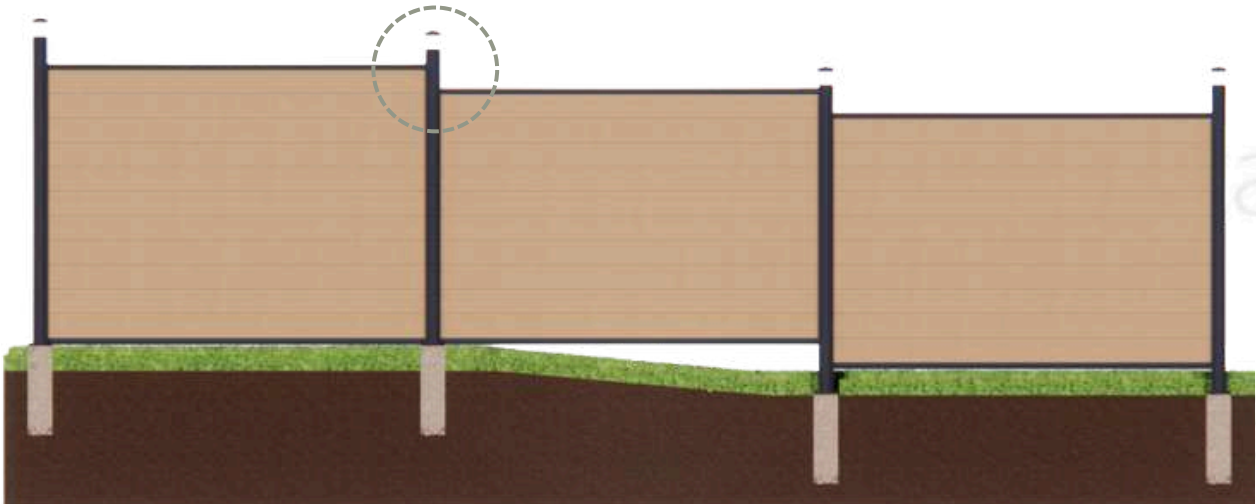

ELEVATION

Fence System

RESFP010608

Fence Profile

RESFT3411208

Fence Top Rail

Cut Fence Post
Insert based

RESFC0404

Fence Post Cap

RESFT3411208

Fence Top Rail

RESFC0404

Fence Post Cap

RESFP04040

Fence Post w/ Insert



ISOMETRIC DETAIL

Fence System



ISOMETRIC DETAIL

Fence System

RESFC0404
Fence Post Cap

RESFP04040
Fence Post w/ Insert

RESFT3411208
Fence Top Rail

RESFP010608
Fence Profile

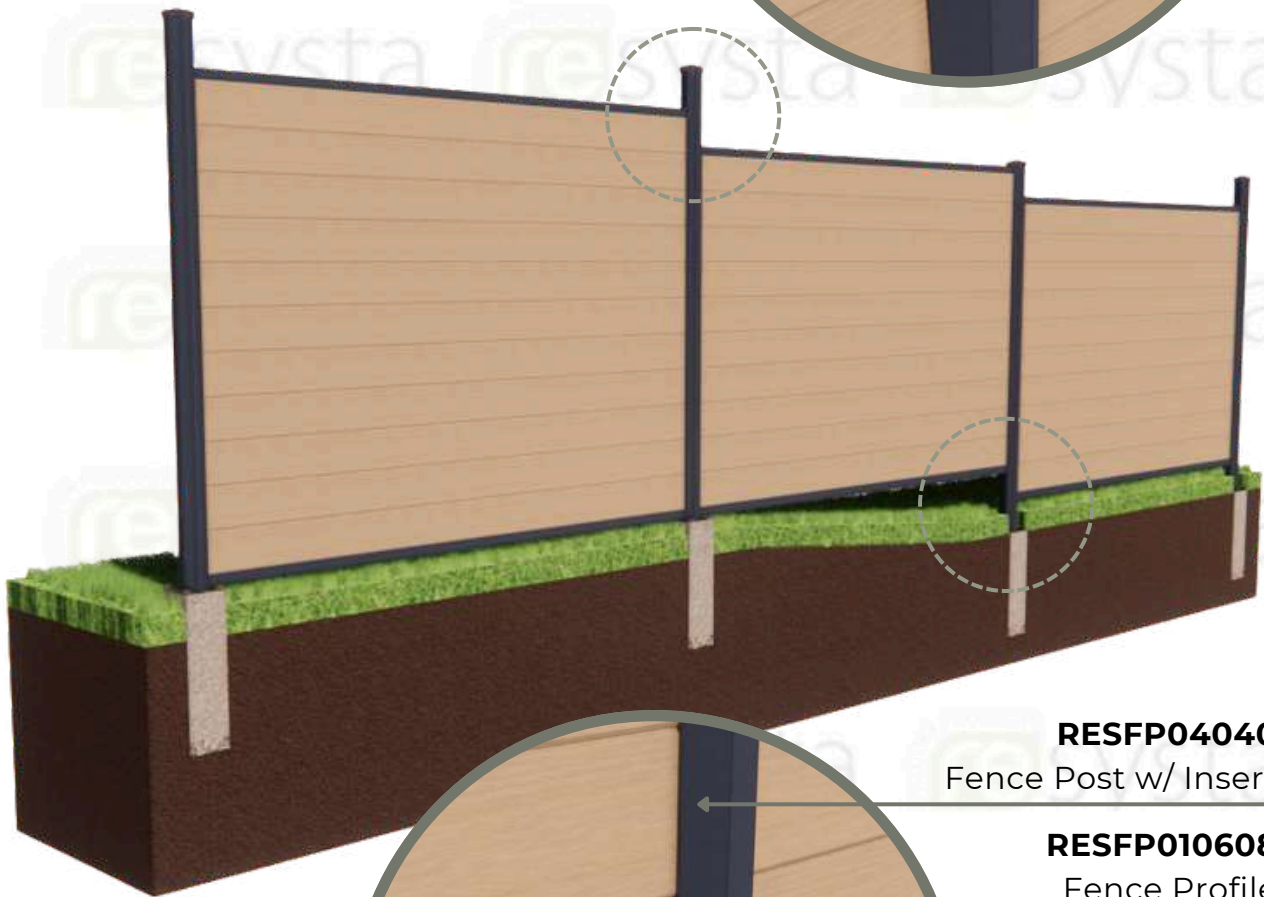

ISOMETRIC DETAIL
Fence System

RESFP04040
Fence Post w/ Insert

RESFP010608
Fence Profile

Cut Fence Insert
based on the
Levelling Line



RESFB3411208
Fence Bottom Rail

SAFETY WARNINGS

Resysta is a Products do not present an inhalation, ingestion, or contact health hazard unless subjected to operations such as sawing, sanding, or machining which result in the generation of airborne particulate. This product contains crystalline silica. Respirable crystalline silica limits are specified by OSHA. Exposure to respirable (fine) silica dust depends on a variety of factors, including activity rate (e.g. cutting rate), method of handling, ventilation, environmental conditions (e.g. weather conditions, workstation orientation), and engineering control measures used. Exposures to respirable crystalline silica above limits established by OSHA are not expected during the normal use of this product. Crystalline silica, has been shown to cause silicosis and has been identified by the State of California, IARC, and NTP as a known human carcinogen. The risk of developing silicosis is dependent upon the exposure intensity and duration. It is recommended that a NIOSH-approved particulate respirator be worn whenever working with this product results in airborne dust exposure.

To view an additional information on our products, please refer to our Resysta website www.resystaUSA.com.